

# Criterion®

## User's Manual

### 18.0cu.ft.Refrigerator

Models: 18TMF-W(453-8143), 18TMF-B(453-8144), 18TMF-SS(453-8145)

#### BEFORE USING YOUR PRODUCT:

Please read this manual carefully and follow all safety rules & operating instructions. Keep this manual for future reference.

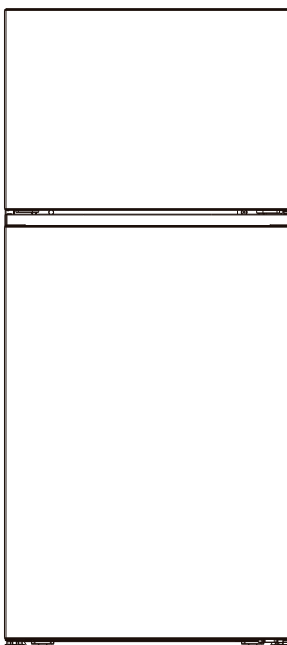

#### OPERATION MANUAL

#### Service Support

 833-953-1758

 24445 Northwestern Hwy, Ste. 101,

 Southfield, MI 48075 833-953-1758

 [Criterion@customer-appliance.com](mailto:Criterion@customer-appliance.com)

# Table of Contents

Important Safety Instructions .....	3
Refrigerator Overview .....	6
Installing Your New Appliance .....	7
Display Controls.....	11
Using Your Appliance .....	12
Cleaning and Care .....	13
Helpful Hints and Tips .....	14
Troubleshooting .....	15
Disposal of the appliance .....	17

## **IMPORTANT**

1. Please read Owner's Manual.
2. Stand refrigerator upright for 4 hours and level appliance prior to plugging in.
3. **DO NOT RETURN TO STORE** before calling Customer Service with questions or problems.

*For questions or assistance, please contact Customer Service at: 1-833-953-1758 between 8:00 am and 4:00 pm EST or email: [Criterion@customer-appliance.com](mailto:Criterion@customer-appliance.com)*

## Important Safety Instructions

Read and follow all safety messages. Save these instructions.



This safety alert symbol will help you understand situations and hazards that may cause injury or death.

### **WARNING**

The **WARNING** alert means a potentially hazardous situation. Serious injury or death may occur if not avoided.

### **DANGER**

The **DANGER** alert means an imminently hazardous situation. Serious injury or death may occur if not avoided.

### **CAUTION**

The **CAUTION** alert means a potentially hazardous situation. Moderate or minor injury may occur if not avoided.

### **WARNING**

1. Please ensure that everyone using this appliance is familiar with its operations and safety features. This appliance is not intended for use by persons (including children) with reduced physical, sensory or mental capabilities, unless supervised or properly instructed.
2. This appliance is intended to be used in residential households and similar applications.
3. Keep explosive and flammable substances away from unit. Do not store these materials in the refrigerator.
4. Disconnect power before servicing or installing an Ice Maker.
5. Use nonflammable cleaner.
6. Use 2 or more people to remove old unit and install this unit.
7. Connect to potable water supply only.
8. Do not use mechanical devices or other means to accelerate the defrosting process, other than those recommended by the manufacturer.
9. Do not damage the refrigerant circuit.

10. Do not use electrical appliances inside the food storage compartments of the appliance, unless they are of the type recommended by the manufacturer.

11. The instructions include the following wording regarding the use of extension cords:

Do not use an extension cord or ungrounded (two prong) adapters.

If the supply cord is damaged, it must be replaced by the manufacturer, its service agent or similarly qualified persons in order to avoid a hazard.

12. Keep ventilation openings, in the appliance enclosure or in the built-in structure, clear of obstruction.

 **DANGER**

To avoid the risks that are always present when using an electric appliance, we recommend that you pay attention to the instructions about electricity below.

1. The appliance requires single phase 115V/60Hz power supply. It has a power cord that has a 3-prong grounding plug that minimizes the possibility of electrical shock. This appliance must be grounded. Do not remove the grounding prong or modify the power plug.
2. The unit should be plugged into a dedicated electrical outlet that meets all current standards and requirements. Do not plug anything else into the same outlet and ensure the appliance is the only thing plugged into the entire circuit. It should have its own dedicated breaker. Otherwise, this may overload the circuit and cause a fire.
3. Do not modify the power plug. The power plug must be accessible when the appliance is installed.
4. The appliance should not be turned off with a switch or other device.
5. Make sure that the plug is not squashed or damaged. Otherwise, it may cause short circuit, electric shock or overheat and even cause a fire.
6. Do not insert the power plug if the socket is loose, there is a risk of electric shock or fire.
7. Switch off the appliance and disconnect it from the main power before you clean or move it.
8. Never unplug the appliance by pulling on the electrical cord. Always grip the plug firmly and pull straight out from the socket to prevent damaging the power cord.
9. Do not operate the appliance without the cover over the interior lighting.

10. Any electrical component must be replaced or repaired by a qualified electrician or authorized service engineer. Only genuine replacement parts should be used.

11. To avoid eye injury, do not look direct into the LED light located in the refrigerator compartment. If it is not functioning correctly, consult a qualified, registered electrician or replace it in accordance with the Cleaning and Care chapter.

12. The refrigerant isobutene (R600a) is contained within the refrigerant circuit of the appliance. During transportation and installation of the appliance, ensure that none of the components of the refrigerant circuit become damaged. The refrigerant (R600a) is flammable.

13. Risk of child entrapment. Before you throw away your old appliance:

- Take off the doors
- Leave the shelves in place so that children may not easily climb inside.

 **CAUTION**

1. Don't store products which contain flammable propellants (e.g. spray cans) or explosive substances in the appliances.
2. Avoid open flames (candles, lamps etc.) and other sources of ignition.
3. Thoroughly ventilate the room in which the appliance is situated.
4. Unpack and check through the appliance. Should any damage be evident, don't plug in the appliance but contact the shop immediately from which you purchased it. Keep all packing materials in this case.
5. We recommend that you wait for 4 hours before connecting the appliance to allow the refrigerant to flow back into the compressor.

### General safety and daily use

It is important to use your appliance safely. We recommend that you follow the guidelines below.

We recommend that you keep this users manual with the appliance for future reference.

This appliance is intended to be used in households and similar applications such as:

- Staff kitchen-areas in shops, offices and other working environments;
- Clients in hotels, motels and other residential environment;
- Bed and breakfast environments;
- Catering and similar non-retail applications.

Children should be supervised to ensure that they do not play with the appliance and given instruction regarding proper use of the appliance.

Store any food in accordance with the storage instructions from the manufacturer.

Don't try to repair the appliance yourself. It is dangerous to alter the specifications or modify this product in any way. Any damage to the power cord may cause a short circuit, fire or electric shock.

Don't place too much food directly against the air outlet on the rear wall of both the refrigerator and freezer compartment, as it may affect sufficient air circulation.

Don't place hot items near the plastic components of this appliance.

Frozen food should not be refrozen once it has been thawed out.

Don't store bottled or canned drinks (especially carbonated drinks) in the freezer compartment. Bottles and cans may explode.

Use caution consuming popsicles or ice cubes straight from the freezer as this can cause freezer burn to the mouth and lips.

### Safety for children and infirm persons

Keep all packaging away from children to avoid risk of suffocation.

Protect children from being scalded by touching the compressor at the rear bottom of appliance.

Don't place items on top of the appliance as this could cause injury should they fall off.

Never allow children to play with the appliance by hanging or standing over or on the doors, racks, shelves and drawers, etc.

# Refrigerator Overview

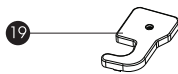
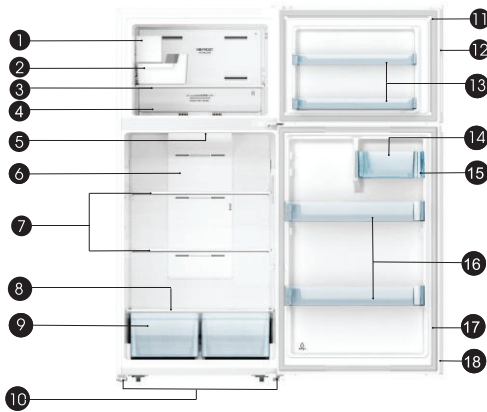

- 1 Automatic Icemaker (Optional)
- 2 Ice Container (Optional)
- 3 Glass Shelf
- 4 Freezer Air Duct
- 5 LED Light
- 6 Fridge Air Duct
- 7 Glass shelves
- 8 Crisper Cover
- 9 Crisper Drawers
- 10 Adjustable bottom feet

- 11 Freezer Door Gasket
- 12 Freezer Door
- 13 Freezer Door Bins
- 14 Dairy Bin Cover
- 15 Dairy Bin
- 16 Gallon Door Bins
- 17 Fridge Door Gasket
- 18 Fridge Door

## Package Contents

- 19 Left hinge cover
- 20 Stopper block (x2)

## Spare parts for reversing the door

- 21 Door stopper (x2)
- 22 Allen wrench

## NOTE

- Due to unceasing modification of our products, your refrigerator may be slightly different from this instruction manual, but its functions and using methods remain the same.
- To get the best energy efficiency of this product, please place all shelves, drawers and baskets on their original position as the illustration above.

# Installing Your New Appliance

Before using the appliance for the first time, you should be informed of the following tips.

## ⚠ Warning!

For proper installation, this refrigerator must be placed on a level surface of hard material that is the same height as the rest of the flooring. This surface should be strong enough to support a fully loaded refrigerator.

The rollers, which are not castors, should be only used for forward or backward movement. Moving the refrigerator sideways may damage your floor and the rollers.

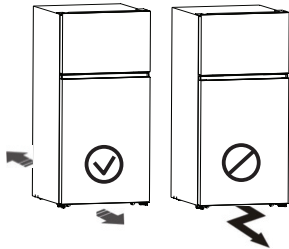

## ⚠ Ventilating the Appliance

In order to improve efficiency of the cooling system and save energy, it is necessary to maintain good ventilation around the appliance for the dissipation of heat. For this reason, sufficient clear space should be available around the refrigerator.

### Suggestion

It is advisable for there to be at least 3 inches (75mm) of clearance from the back of the fridge to the wall, at least 3.9 inches (100mm) of clearance from its top, at least 3.9 inches (100mm) from its side to the wall and a clear space in front to allow the doors to open 125°. As shown in following diagrams.

A	58.1 " (1476mm )
B	30.7 " (779mm )
C	29.5 " (750mm)
D	47.3 " (1 201mm)

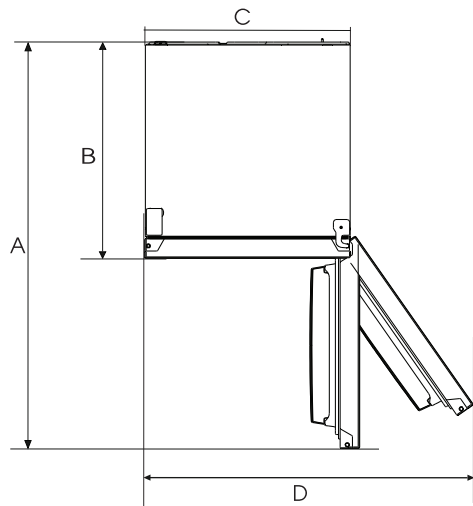
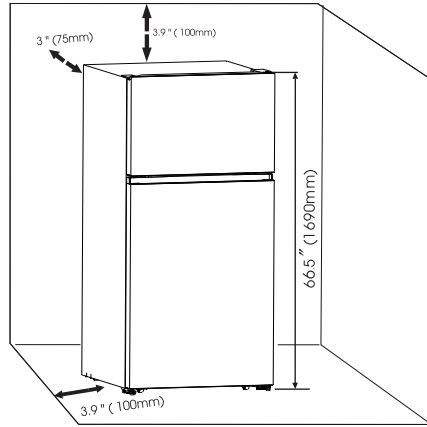

### Note:



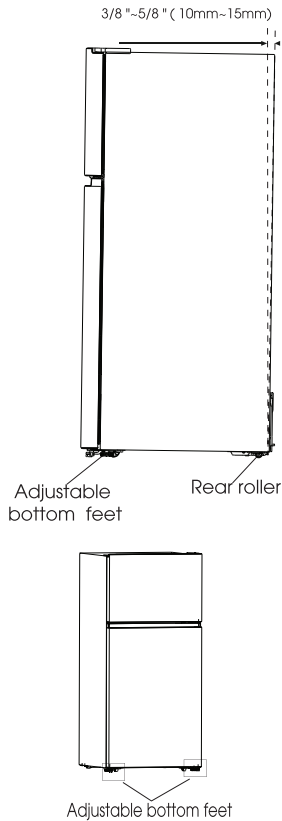

- This appliance performs well with ambient temperature between 55°F (12.8°C) to 110°F (43.3°C). The appliance may not work properly if left at a temperature above or below the indicated range.
- Stand your appliance in a dry place to avoid high moisture.
- Keep the appliance out of direct sunlight, rain or frost. Stand the appliance away from heat sources such as stoves, fires or heaters.

## Leveling the Appliance

- For sufficient leveling and air circulating in the lower rear section of the appliance,the bottom feet may need to be adjusted. You can adjust them manually by hand.
- To allow the doors to self-close, tilt the top backwards by 3/8~5/8 inches (10-15mm).

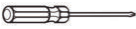

## Tools you may need

Not provided		
	Phillips Screwdriver	Socket Wrench (5/16", 8mm)
Not provided		
	Slotted Screwdriver	Putty Knife
Provided		
	Allen Wrench (5/32", 4mm)	

## Reversing the Fridge Door

The side at which the door opens can be changed, from the right side (as supplied) to the left side, if the installation site requires.

### Warning!

When reversing the door, the appliance must not be connected to the mains. Ensure that the plug is removed from the power socket.

### Note:

When required, tilt the refrigerator back in order to gain access to the base, you should rest the appliance on soft foam packaging or similar material to avoid damaging the backboard of the refrigerator. To reverse the door, the following steps are generally recommended.

1. Stand the refrigerator upright. Open the upper door to take out all door racks (to avoid damaged racks) and then close the door.

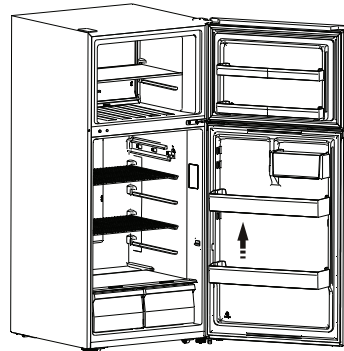

2. With the door closed, remove screws (you can pry it up with a Philips Screwdriver) and the upper hinge cover (you can pry it up with a Slotted Screw driver) (E) on the top right side of appliance and remove 3 special flange screws (F) with a Socket Wrench. Keep the upper hinge cover for future reference.

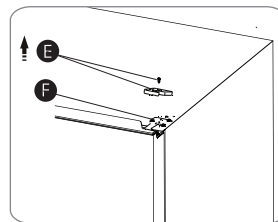



3. Remove the upper hinge (Please hold upper door by hand when installing). Keep it for future use.

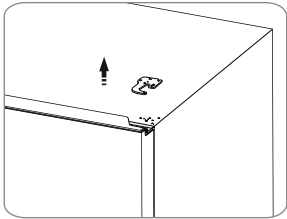

4. Use both hands to open the door more than 90°. Lift it up and take it off.

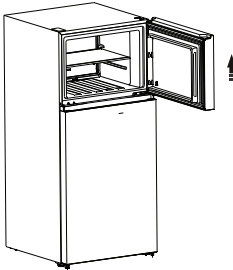

5. Loosen the two screws (G) on the right bottom of the freezer door, then take out the right stopper block (H) and the right door stopper (I). Then install the left stopper block (K) and the left door stopper (J) (provided in the plastic bag).

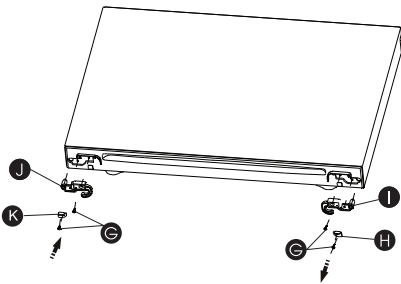

6. Open the fridge door, loosen 2 screws (L) with a 4mm Allen Wrench (provided in plastic) and loosen 1 screw (N) with a Philips Screwdriver, then remove middle hinge (M). Keep the middle hinge (M) for future use. Remove the fridge door from the lower hinge.

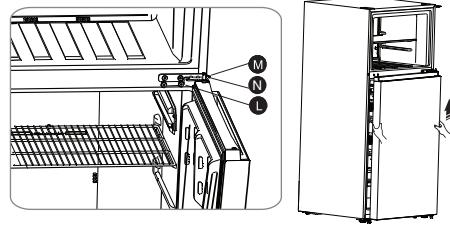

7. Place the fridge door on a smooth surface with its panel upward. Loosen the two screws (G) on the right bottom of the fridge door, then take out the right stopper block (H) and the right door stopper block (I). Then install the left stopper block (K) and the left door stopper (J).

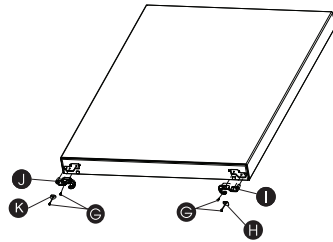

8. Install the screw (N) on the rightest hole, change the screw hole covers on the middle cover plate from left to right.

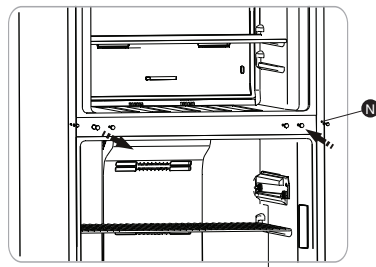

9. Lay the refrigerator on soft foam packaging or similar material. Remove both adjustable bottom feet parts, and the lower hinge part by unscrewing the special flange self-tapping screws. Loosen the lower hinge axis then install it on the reverse hole site.

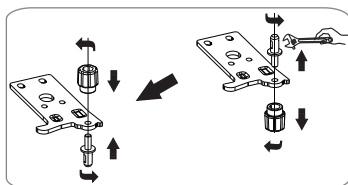
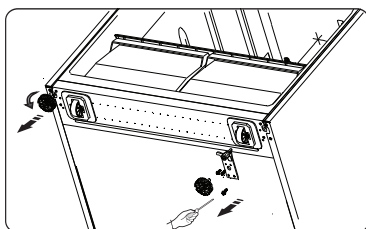

10. Move the lower hinge part to the left side and screw it on with the special flange self-tapping screws. Move the adjustable bottom feet parts to the other side and screw them.

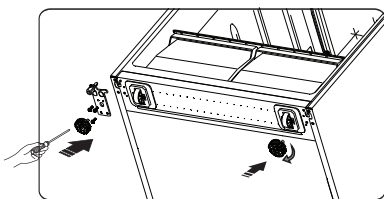

11. Stand the refrigerator upright and carefully slot the fridge door onto the lower hinge pin and hold it in position.

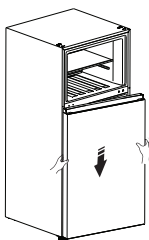

12. Turn the middle hinge part 180 degrees, insert the middle hinge axis into the hole in the upper left side of the fridge door and tighten the bolts.

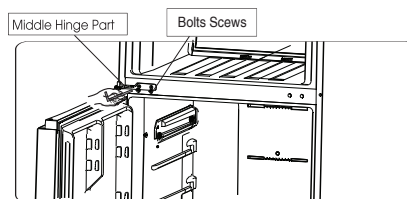

13. Hold the freezer door in the appropriate position. Make sure the door is level and insert the middle hinge axis into the into the lower hole of the freezer door.

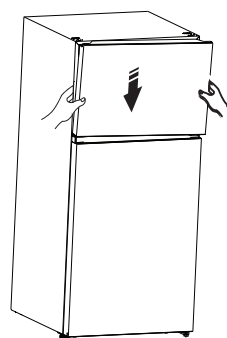

14. Screws out the upper hinge axis, turn the upper hinge over and fix axis on it. Then attach it on the top left side.

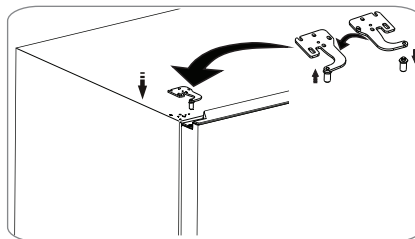

15. Remove the upper hinge cover from the plastic bag provided, and install it and fix it with screws.

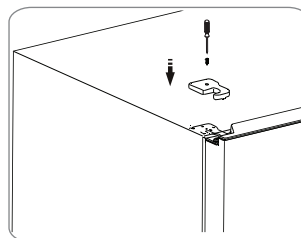

# Display Controls

Please read the temperature regulation method carefully before use, and the compartment temperature of the fridge can be adjusted through the control panel. Usually use the fridge, set the regulator to the middle position. If required, see the following method:

Temperature Setting Recommendation		
Seasonal Temperature	Freezer Compartment	Refrigeration Compartment
Summer (Above 89.6°F)	<p>Set to around ¼ from left towards "Coldest"</p>	<p>Set between 3~4</p>
Normal	<p>Set to middle position</p>	<p>Set to middle position</p>
Winter (Below 53.6°F)	<p>Set to around ¾ from left towards "Coldest"</p>	<p>Set between 4~5</p>
Unrecommended settings		
Compartment	Setting	Effect
Freezer		It may cause the freezer compartment temperature increases.
Freezer		It may cause the refrigeration compartment temperature increases.
Refrigeration	<p>Set to 1</p>	It may cause the freezer compartment temperature increases.
Refrigeration	<p>Set to 5</p>	It may lead to the more energy consumption.



## Demo mode

Demo mode is for store display, and it prevents the refrigerator from generating cool air. In this of Cooling Off Mode, the refrigerator may seem like it is working but it will not make cool air. Press the "SETTING" button for 5 seconds, and the refrigerator will be set into demo mode. Then all of the figures on the control panel will lighten. To cancel this mode, press "SETTING" for 5 seconds and the refrigerator begins cooling again.

## Important!

Don't place too much food directly against the air outlet of the temperature sensor part in the air channel cover of the refrigerator compartment, as it will affect the proper operation of the appliance.

## Fridge

You can press the "SETTING" button to select a temperature setting. When you press the button continuously, the temperature will be set in the following sequence.

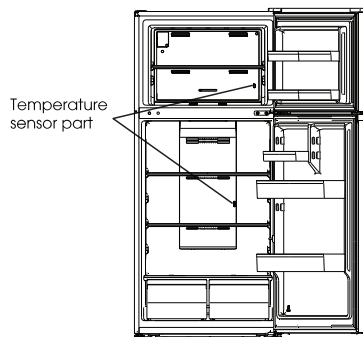
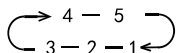

## Using your Appliance

This section tells you how to use most of the useful features. We recommend that you read through them carefully before using the appliance.

### 1. Using your Refrigerator Compartment

The refrigerator compartment is suitable for storage of vegetables and fruit. Food inside should be packed to store in order to avoid losing moisture or flavor permeating into other foods.

#### CAUTION

Never close the refrigerator door while the shelves, crisper and/or telescopic slides are extended. It may damage both them and the refrigerator.

#### Wire shelves and door bins

The refrigerator compartment is provided with shelf parts and door bins, which are suitable for the storage of eggs, canned liquid, bottled drinks and packed food. They can be placed at different heights according to your needs. However, do not place too many heavy things in the bins. Before you lift up the door bin vertically, please take the food out.



#### Crisper Drawer

This is suitable for storage of fruits and vegetables. It can be removed for cleaning. To remove open the door fully. Then pull out the drawer and tilt up the front of the crisper after moving slightly.

#### Using the Freezer Compartment

The freezer compartment is provided with a glass shelf.

### 3. Automatic ice-maker model IM-HSN1 (453-4479) (not included).

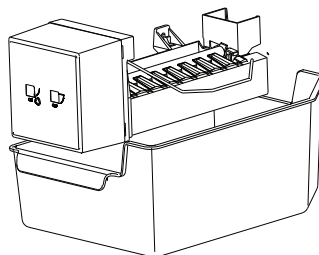

#### Note:

- When the ice maker dumps ice into the ice box, any sounds are part of normal operation.
- If ice is not dispensed for a long period of time, it may clump in the ice bin. If this occurs, please remove all the ice and empty the bin.
- In case of prolonged absence and no ice maker use, close the water valve to prevent leaks.

It is recommended that the first several ice charges be discarded to ensure the highest quality of ice. Do not store cans or containers that will burst when frozen.

#### CAUTION

Do not allow your children to touch the ice maker. This could cause injury.

## Cleaning and Care

For hygienic reasons the appliance (including exterior and interior accessories) should be cleaned at least every two months.

### CAUTION

**The appliance must not be connected to a power source during exterior or interior cleaning. Danger of electrical shock! Before cleaning, switch the appliance off and remove the plug from the wall outlet socket.**

#### Exterior Cleaning

To maintain good appearance of your appliance, you should clean it regularly.

Spray water onto a cleaning cloth instead of spraying directly on the surface of the appliance. This helps ensure an even distribution of moisture to the surface.

Clean the doors, handles and cabinet surfaces with a mild detergent and then wipe dry with a soft cloth.

### CAUTION

Don't use sharp objects to clean as they are likely to scratch the surface.

Don't use thinner, Car detergent, bleach, ethereal oil, abrasive cleansers or organic solvent such as Benzene for cleaning. They may damage the surface of the appliance and may cause fire. **You should use mild detergent for the cleaning.**

#### Interior Cleaning

You should clean the appliance interior regularly. It will be easier to clean when food stocks are low. Wipe the inside of the fridge and freezer with a weak solution of baking soda and water, and then rinse with warm water using a wrung-out sponge or cloth. Wipe completely dry before replacing the shelves and baskets. Thoroughly dry all surfaces and removable parts before putting them back into place. Although this appliance automatically defrosts,

a layer of frost may occur on the freezer compartments interior walls if the freezer door is opened frequently or kept open too long. If the frost is too thick, choose a time when the freezer is nearly empty and proceed as follows:

1. Remove existing food and accessory baskets, unplug the appliance from the main power and leave the doors open. Ventilate the room thoroughly to accelerate the process.
2. When defrosting is completed, clean your freezer as described above.

### WARNING

Do not use sharp objects to remove frost from the freezer compartment. Only after the interior is completely dry should the appliance be switched back on and plugged back into the main socket.

#### Door Gasket Cleaning

Take care to keep the door gasket clean. Sticky food and drinks can cause the gasket to stick to the cabinet and tear when you open the door. Wash gasket with a mild detergent and warm water. Rinse and dry the gasket thoroughly after cleaning.

### CAUTION

Only after the door seals are completely dry should the appliance be powered on.

#### Replacing the LED Light

Warning: The LED light must be replaced by a competent person. If the LED light is damaged, follow the steps below:

1. Unplug your appliance.
2. Remove the light cover by lifting up and pulling out the LED light.
3. Hold the LED light with one hand and pull it with the other hand while pressing the connector latch.
4. Replace the LED light and snap it correctly in place and reattach the light cover.

## Helpful Hints and Tips

### Energy Saving Tips

We recommend that you follow the tips below to save energy.

Try to avoid keeping the door open for long periods in order to conserve energy. Ensure the appliance is away from any sources of heat (direct sunlight, electric oven or cooker etc.)

Don't set the temperature colder than necessary.

Don't store warm food or evaporating liquid in the appliance.

Place the appliance in a well ventilated, humidity free room. Please refer to the Installing your New Appliance chapter.

If the diagram shows the correct combination for the drawers, crisper and shelves, do not adjust the combination as this is designed to be the most energy efficient configuration.

### Tips for Fresh Food Refrigeration

Do not place hot food directly into the refrigerator or freezer, the internal temperature will increase resulting in the compressor having to work harder, and consume more energy.

Do cover or wrap the food, particularly if it has a strong flavor.

Place food properly so that air can circulate freely around it.

**Note:** Please check page 11 as a reference for suggested refrigerator settings.

### Tips for Refrigeration

For Meat: (all types) wrap in cling wrap and place on the glass shelf above the vegetable drawer. Always follow food storage times and use by dates suggested by manufacturers.

Cooked food, cold dishes, etc.:  
These should be covered and placed on any shelf.

Fruit and vegetables:  
These should be stored in the special drawer provided.

Butter and cheese:  
Should be wrapped in airtight foil or plastic film wrap.

Milk bottles:  
Should have a lid and be stored in the door bins.

### Tips for Freezing

When first starting-up or after a period of no use, let the appliance run at least 2 hours on the higher settings before putting food in the compartment.

Prepare food in small portions to enable it to be rapidly and completely frozen and to make it possible to subsequently thaw only the quantity required.

Wrap up the food in aluminum foil or cling wraps which are airtight.

Do not allow fresh, unfrozen food to touch the food which is already frozen to avoid temperature rise of the latter.

Iced products, (ice cubes, popsicles):  
If consumed immediately after removal from the freezer compartment, will probably cause frost burns to the skin.

It is recommended to label and date each frozen package in order to keep track of the storage time.

### Hints for the Storage of Frozen Food

Ensure that frozen food has been stored correctly by the food retailer.

Once defrosted, food will deteriorate rapidly and should not be re-frozen. Do not exceed the storage period indicated by the food manufacturer.

### Switching off your Appliance

If the appliance needs to be switched off for an extended period, the following steps should be taken to prevent mold on the appliance.

1. Remove all food.
2. Remove the power plug from the main socket. socket.
3. Clean and dry the interior thoroughly.
4. Ensure that all the doors are wedged open slightly to allow air to circulate.

# Troubleshooting

If you experience a problem with your appliance or are concerned that the appliance is not functioning correctly, you can carry out some easy checks before calling for service, please see below.

## WARNING

1. Don't try to repair the appliance yourself. If the problem persists after you have made the checks mentioned below, contact a qualified electrician, authorized service engineer or the shop where you purchased the product.
2. A child entrapment warning statement is included in either the operating instructions or in a use and care manual provided with each refrigerator.

Problem	Possible Cause & Solution
<b>Appliance is not working correctly</b>	Check whether the power cord is plugged into the power outlet properly.
	Check the fuse or circuit of your power supply, replace if necessary.
	The ambient temperature is too low. Try setting the chamber temperature to a colder level to solve this problem.
	It is normal that the freezer does not operate during the defrost cycle, or for a short time after the appliance is switched on to protect the compressor.
<b>Odors from the compartments</b>	The interior may need to be cleaned
	Some food, containers or wrapping cause odors.
<b>Noise from the appliance</b>	The sounds below are quite normal: Compressor making noises. Air movement noise from the small fan motor in the freezer compartment or other compartments. Gurgling sound similar to water boiling. Popping noise during automatic defrosting. Clicking noise before the compressor starts. Clicking noise when you get the water. The motor running noises when you get ice.
	Other unusual noises are due to the reasons below and may need you to check and take action: The cabinet is not level. The back of appliance is touching the wall. Bottles or containers have fallen or are rolling.

<p><b>The motor runs continuously</b></p>	<p>It is normal to frequently hear the sound of the motor, it will need to run more under the following circumstances:  Temperature setting is set colder than necessary.  Large quantity of warm food has recently been stored within the appliance.  The temperature outside the appliance is high.  Doors are kept open too long or too often.  After installing the appliance or it has been switched off for a long time.</p>
<p><b>A layer of frost occurs in the compartment</b></p>	<p>Check that the air outlets are not blocked by food and ensure food is placed within the appliance to allow sufficient ventilation. Ensure that the door is fully closed. To remove the frost, please refer to the Cleaning and Care chapter.</p>
<p><b>Temperature inside is too warm</b></p>	<p>You may have left the doors open too long or too frequently; or the doors are kept open by some obstacle; or the appliance is located with insufficient clearance at the sides, back and top.</p>
<p><b>Temperature inside is too cold</b></p>	<p>Increase the temperature by following the Display Controls chapter.</p>
<p><b>Doors can't be closed easily</b></p>	<p>Check whether the top of the refrigerator is tilted back by 10-15mm to allow the doors to self-close, or if something inside is preventing the doors from closing.</p>
<p><b>The light is not working</b></p>	<p>The LED light may be damaged. Refer to replace LED lights in Cleaning and Care chapter.  The control system has disabled the lights due to the door being kept open too long. Close and reopen the door to reactivate the lights.</p>
<p><b>Hear water bubbling in the refrigerator</b></p>	<p>This is normal. The bubbling comes from the refrigerant coolant liquid circulating through the refrigerator.</p>



## Disposal of the Appliance

### DANGER

It is prohibited to dispose of this appliance as household waste.

#### Packaging Materials

Packaging materials with the recycle symbol are recyclable. Dispose of the packaging into a suitable waste collection container to recycle it.

#### Before Disposal of the Appliance

1. Pull out the main plug from the main socket.
2. Cut off the power cord and discard with the main plug.

### WARNING

Potential Suffocation Hazard! Potential death or brain damage could occur. Remove doors to prevent potential suffocation.

1. To prevent potential suffocation hazard, remove your old refrigerators doors completely, immediately. Leave shelves installed to help block children from climbing on or getting inside.
2. When disposing of the appliance do so only at an authorized waste disposal center. Do not expose to flame.

Refrigerators contain refrigerant and gases in the insulation. Refrigerant and gases must be disposed of professionally as they may cause eye injuries or ignition. Ensure that tubing of the refrigerant circuit is not damaged prior to proper disposal.

	Correct Disposal of this product
	<p>This symbol on the product or in its packing indicates that this product may not be treated as household waste. Instead, it should be taken to the appropriate waste collection point for the recycling of electrical and electronic equipment. By ensuring this product is disposed of correctly, you will help prevent potential negative consequences for the environment and human health, which could otherwise be caused by the inappropriate waste handling of this product. For more detailed information about the recycling of this product, please contact your local council, your household waste disposal service, or the shop where you purchased the product.</p>

# One Year Limited Warranty

Manufacturer provides a limited warranty for each new refrigerator to be free from defects in material and workmanship for a period of 1 year from the date of purchase. Manufacturer agrees to remedy any such defective inside accessory components such as door panels, door shelves, racks, handles, casters, bins and drawers or to furnish a new unit if the unit proves to have failed, at the company's option, for one year from your original date of purchase.

Buyer must register unit at: [PlasticDevelopmentGroup.com/applianceregistration](http://PlasticDevelopmentGroup.com/applianceregistration).

In the event the unit requires replacement or refund under the terms of this limited warranty, the Buyer is responsible for all transportation expenses to return the unit prior to receiving a replacement unit or refund. A copy of the dated sales receipt/invoice is required to receive benefits of this limited warranty.

This limited warranty covers appliances in use within the continental United States, Alaska, and Hawaii, and Puerto Rico.

This limited warranty does not cover the following:

1. Products with original serial numbers that have been removed, altered or cannot be readily determined.
2. Products that have been transferred from its original owner to another party or removed outside the USA.
3. Rust on the interior or exterior of the unit.
4. Damages due to shipping damage or improper installation.
5. Damages due to misuse or abuse.
6. Service calls, repairs, and labor expenses for any purpose.
7. Content losses and food spoilage due to failure of the unit.
8. Punctures to the evaporation system due to improper defrosting of the unit.
9. Replacement or resetting of house fuses or circuit breakers.
10. Failure or defects of this product if used for other purposes than its intended purpose or used other than in accordance with the provided instructions.
11. Disposal costs for failed unit not returned to Manufacturer.
12. Any delivery/installation costs incurred as the result of a unit that fails to perform as specified.
13. Expenses for travel and transportation for product if you are exchanging or returning the unit.
14. Expenses related to the removal and re-installation of your unit or for making the unit accessible, such as removal of trim, cupboards, shelves, etc. or if not installed in accordance with the provided installation instructions.
15. Damages to the finish of the unit or home incurred during installation, including but not limited to floors, cabinets, walls, etc.
16. Damages caused by external causes such as abuse, misuse, inadequate power supply, accidents, fires, or acts of God.
17. Refunds for returned products are limited to the price paid for the unit per the sales receipt.

## **Disclaimer of Implied Warranties, Limitation of Remedies and Exclusions:**

EXCEPT FOR THE EXPRESS WARRANTIES SET FORTH HEREIN, MANUFACTURER MAKES NO WARRANTY WHATSOEVER (OR THE SHORTEST PERIOD ALLOWED BY LAW) REGARDING THE GOODS, INCLUDING ANY (1) WARRANTY OF MERCHANTABILITY; (2) WARRANTY OF FITNESS FOR A PARTICULAR PURPOSE; (3) WARRANTY OF TITLE; OR (4) WARRANTY AGAINST INFRINGEMENT OF INTELLECTUAL PROPERTY RIGHTS OF A THIRD PARTY; WHETHER ARISING BY LAW, COURSE OF DEALING, COURSE OF PERFORMANCE, USAGE OF TRADE, OR OTHERWISE. BUYER ACKNOWLEDGES THAT IT HAS NOT RELIED ON ANY REPRESENTATION OR WARRANTY MADE BY MANUFACTURER, OR ANY OTHER PERSON ON MANUFACTURER'S BEHALF. REPLACEMENT OF UNIT AND LISTED PARTS IN ACCORDANCE WITH THE TERMS HEREIN, IS YOUR SOLE AND EXCLUSIVE REMEDY UNDER THIS LIMITED WARRANTY. MANUFACTURER IS NOT LIABLE FOR INCIDENTAL OR CONSEQUENTIAL DAMAGES AND NO REPRESENTATIVE OR PERSON IS AUTHORIZED TO ASSUME FOR MANUFACTURER ANY OTHER LIABILITY IN CONNECTION WITH THE SALE OF THIS PRODUCT. UNDER NO CIRCUMSTANCE IS THE CONSUMER PERMITTED TO RETURN THE UNIT TO MANUFACTURER WITHOUT THE PRIOR WRITTEN CONSENT OF MANUFACTURER.

Customer Service, (toll free: 833-953-1758) between the hours of 8:00 am and 4:00 pm EST

EMAIL: [Criterion@customer-appliance.com](mailto:Criterion@customer-appliance.com)

Product Registration: [plasticdevelopmentgroup.com/applianceregistration](http://plasticdevelopmentgroup.com/applianceregistration)

 **CALIFORNIA RESIDENTS ONLY-WARNING:** Cancer and Reproductive  
Harm-[www.P65Warnings.ca.gov](http://www.P65Warnings.ca.gov)

Customer Service, (toll free: 833-953-1758) between the hours of 8:00 am and 4:00 pm EST  
EMAIL: [Criterion@customer-appliance.com](mailto:Criterion@customer-appliance.com)  
Product Registration: [plasticdevelopmentgroup.com/applianceregistration](http://plasticdevelopmentgroup.com/applianceregistration)