

Criterion™

User's Manual

Top Load Washer

MODEL: CTW41N1AW

Before using your product, please read this manual carefully and keep it for future reference.

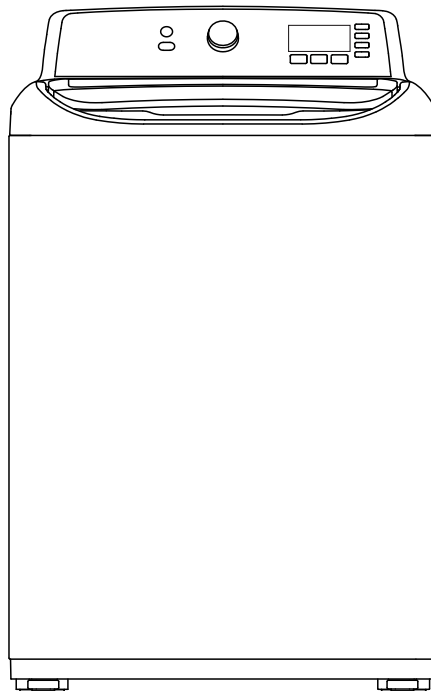

Contents

Important Safety Instructions	3
Features	7
Package contents	7
Main components	8
Control panel	9
Unpacking your washer	10
Choosing a location	11
Washer dimensions and installation measurements	11
Electrical requirements	13
Water requirements	14
Drainage requirements	14
Installing your washer	15
Tools you will need	15
Step-by-Step instructions	15
Using your washer	22
Washing a load of laundry	22
Setting the child lock	25
Washer options and settings	25
Maintaining your washer	26
Cleaning the exterior	26
Cleaning the interior	26
Cleaning the control panel	26
Cleaning the detergent, bleach, or softener compartment	26
Cleaning the tub	26
Storing your washer	26
Troubleshooting	26
Understanding the error codes	28
Specifications	28
Fabric Care Chart	29

SAFETY and PRECAUTIONS

Top-Load Washer

Important Safety Instructions

SAVE THESE INSTRUCTIONS

This User Guide contains important information on the installation, use, and care of your appliance. Please read this guide carefully before installation and operation of this machine to prevent injury and property damage.

The Warnings and Important Safety Instructions in this guide do not cover all possible conditions and situations that may occur. It is your responsibility to use common sense, caution, and care when installing, maintaining, and operating your washer.



This indicates that hazards or unsafe practices may cause serious personal injury or death.



WARNING

To reduce the risk of fire, explosion, electric shock, or personal injury when using your washing machine, you **SHOULD** follow these basic safety precautions.



CAUTION

This indicates that hazards or unsafe practices may cause minor personal injury or property damage.



This symbol indicates that there are important operating and maintenance instructions in the literature accompanying your washing machine.

State of California Proposition 65 Warnings

The California Safe Drinking Water and Toxic Enforcement Act requires the Governor of California to publish a list of substances known to the State of California to cause cancer, birth defects, or other reproductive harm, and requires businesses to warn of potential exposure to such substances. This product contains a chemical known to the State of California to cause cancer, birth defects, or other reproductive harm. This appliance can cause low-level exposure to some of the substances listed, including benzene, formaldehyde, and carbon monoxide.

Cancer and Reproductive Harm
- www.P65Warnings.ca.gov.

WARNING

Do not store or use gasoline or other flammable vapors and liquids in the vicinity of this or any other appliance.

Basic Precautions



WARNING

- 1 Read all instructions before using the appliance.
- 2 Use this appliance only for its intended purpose as described in this User Guide.
- 3 Before use, the washer must be properly installed as described in this guide.
- 4 Always follow the fabric care instructions supplied by the garment manufacturer.
- 5 Do not wash or dry articles that have been previously cleaned in, washed in, soaked in, or spotted with gasoline, dry-cleaning solvents, or other flammable or explosive substances as they give off vapors that could ignite or explode.
- 6 Do not allow children to play on or in the appliance. Close supervision of children is necessary when the appliance is used near children.
- 7 Before the appliance is removed from service or discarded, remove the lid of the washing compartment.
- 8 Do not reach into the appliance if the tub is moving.
- 9 Do not install or store this appliance where it will be exposed to the weather or freezing temperatures.
- 10 Do not tamper with the controls.
- 11 Do not repair or replace any part of the appliance or attempt any servicing unless it is specifically recommended in the user-maintenance instructions or in published user-repair instructions that you understand.

SAFETY and PRECAUTIONS

- 12 Hydrogen gas is explosive. If the hot water system has not been used for two weeks or more, before using a washer, turn on all hot water faucets and let the water flow from each for several minutes. This will release any accumulated hydrogen gas. The gas is flammable, so do not smoke or use an open flame during this time.
- 13 Keep the area underneath and around your appliance free of combustible materials (lint, paper, rags, and so on), gasoline, chemicals, and other flammable vapors and liquids.
- 14 Do not place items exposed to cooking oil in your washer. Items contaminated with cooking oil may contribute to a chemical reaction that could cause a load to catch fire.
- 15 This washer is not designed for maritime use or for mobile installations such as in RVs, aircraft, and other mobile platforms.
- 16 Turn off the water faucets and unplug the washer if the machine is to be left for an extended period of time, such as during vacations.
- 17 Packaging material can be dangerous for children. There is a risk of suffocation! Keep all packaging away from children.
- 18 Always check the inside of the washer for foreign objects before loading laundry. Keep the lid closed when not in use.
- 4 Plug the power plug into the wall socket firmly. Do not use a damaged power plug, or loose wall socket, because this may result in electric shock or fire.
- 5 Do not pull or excessively bend the power cord. Do not twist or tie the power cord.
- 6 Do not hook the power cord over a metal object, place a heavy object on the power cord, insert the power cord between objects, or push the power cord into the space behind the appliance, because this may result in electric shock or fire.
- 7 Do not pull the power cord when unplugging the power plug.
 - Unplug the power plug by holding the plug.
 - Failing to do so may result in electric shock or fire.
- 8 If the power plug or power cord are damaged, contact your nearest service center.
- 9 Do not install on carpet. Install the washer on a level and solid floor that can support its weight. Failure to do so may result in abnormal vibrations, noise, or problems with the product.
- 10 The washer is heavy. Two or more people may be needed to install and move the appliance. Failure to do so may result in bodily or other injuries.
- 11 Store and install the washer where it will not be exposed to temperatures below freezing or exposed to outdoor weather conditions. Failure to do so may result in serious leak damage.
- 12 Position the appliance so that the power plug is easily accessible. Failure to do so may result in electric shock or fire due to an electrical short circuit.
- 13 Failure to follow all of the safety warnings in this guide may result in property damage, or injury to persons.



WARNING

Installation Warnings and Precautions

- 1 Plug the power cord into an AC 120V/60Hz wall socket rated at 15 amps or higher. Use the socket for this washer only. Do not use an extension cord.
 - Sharing a wall socket with another appliance, using a power strip, or extending the power cord may result in electric shock or fire.
 - Do not use an electric transformer. It may result in electric shock or fire.
 - Make sure that the power voltage, frequency, and current match the product's specifications. Failing to do so may result in electric shock or fire.
- 2 Remove all foreign substances such as dust or water from the power plug terminals and contact points using a dry cloth on a regular basis.
 - Unplug the power plug and clean it with a dry cloth.
 - Failing to do so may result in electric shock or fire.
- 3 Plug the power plug into the wall socket in the right direction so that the cord runs towards the floor.
 - If you plug the power plug into the socket in the opposite direction, the electric wires within the cable may be damaged and this may result in electric shock or fire.



WARNING

Use and Maintenance Warnings and Precautions

- 1 If the appliance is flooded, cut the power immediately and contact your nearest service center.
- 2 If the appliance emits a strange noise, a burning smell, or smoke, unplug the power plug immediately and contact your nearest service center. Failure to do so may result in electric shock or fire.
- 3 In the event of a gas leak (such as propane or LP gas), ventilate the area immediately. Do not turn any appliance or light on or off.
 - Do not use a ventilating fan.
 - A spark may result in an explosion or fire.
- 4 Do not force the washer lid open while the washer is operating (high-temperature washing, drying, or spinning).
 - Water flowing out of the washer may cause burns or cause the floor to be slippery. This may result in injury.
 - Forcing the lid open can damage the product or cause injury.

SAFETY and PRECAUTIONS

Top-Load Washer

- 5 Make sure to remove the packaging (sponge, styrofoam) attached to the bottom of the washer before using it.
- 6 Do not insert your hand or a metal object under the washer. This may result in injury.
- 7 Do not attempt to operate this appliance if it is damaged, malfunctioning, partially disassembled, or has missing or broken parts, including a damaged cord or plug. This may result in electric shock, fire, or death.
- 8 Do not touch the power plug with wet hands. This may result in electric shock.
- 9 Do not turn the appliance off by unplugging the power plug while the washer is in operation. Plugging the power plug into the wall socket again may cause a spark and result in electric shock or fire.
- 10 Keep all packaging material well out of the reach of children, as packaging materials can be dangerous to children. If a child places a bag over his or her head, he or she may suffocate.
- 11 Do not let children or infirm persons use this washer unsupervised. Failure to do so may result in electric shock, burns, or injury.
- 12 Do not attempt to repair, disassemble, or modify the appliance yourself.
 - Do not use any fuse (such as copper, steel wire, etc.) other than the standard fuse.
 - If you need to repair or reinstall the appliance, contact your nearest service center.
 - Failure to do so may result in electric shock, fire, problems with the product, or injury.
- 13 If any foreign substance such as water enters the appliance in any area other than the tub, unplug the power plug and contact your nearest service center. Failure to do so may result in electric shock or fire.
- 14 If the water supply hose comes loose from the faucet and floods the appliance, unplug the power plug. Failure to do so may result in electric shock or fire.
- 15 Do not mix chlorine bleach with ammonia or acids such as vinegar. Incorrect usage can produce poisonous gas, resulting in serious injury.
- 16 Do not reach into the washer while parts are moving. Before loading, unloading, or adding items, press the **Start/Pause** button and allow the tub to come to a complete stop before reaching inside. Failure to do so may result in electric shock, injury, or fire.
- 17 Do not allow children to play on or in the washer. Close supervision of children is necessary when the washer is used near children. As children grow, teach them the proper, safe use of all appliances. Failure to do so may result in serious injury.
- 18 Keep laundry products out of reach of children. Observe all warnings on product labels and follow them. Failure to do so may result in serious injury.
- 19 Disconnect this appliance from the power supply before attempting any user maintenance. Pressing the **Power** button does not disconnect this appliance from the power supply. Failure to do so may result in electric shock, injury, or fire.
- 20 Do not clean the appliance by spraying water directly onto it.
- 21 Do not use benzene, thinner, or alcohol to clean the appliance. This may result in discoloration, deformation, damage, electric shock, or fire.
- 22 Unplug the power plug when the appliance is not being used for long periods of time or during a thunder/lightning storm. Failure to do so may result in electric shock or fire.
- 23 Keep hands and foreign objects clear of the lid and latch area when closing the lid. Failure to do so may result in personal injury.
- 24 If the washer is contaminated by a foreign substance such as detergent, dirt, or food waste, unplug the power plug and clean the washer with a damp, soft cloth. Failure to do so may result in discoloration, deformation, damage, or rust.
- 25 The clear portion of the lid can be broken by a strong impact. Take care when using the washer. If the clear portion is cracked or broken, it may result in injury.
- 26 After a water supply failure or when reconnecting the water supply hose, open the faucet slowly.
- 27 Open the faucet slowly after a long period of non-use. The air pressure in the water supply hose or the water pipe may result in damage to a part or in water leakage.
- 28 If a drain error occurs during an operation, check if there is a draining problem. If the washer is used when it is flooded because of a draining problem, it may result in electric shock or fire due to an electrical short circuit. Do not insert your hand or a metal object under the washer. This may result in injury.
- 29 Insert laundry into the washer completely so that the laundry does not get caught in the lid. If laundry gets caught in the lid, it may result in damage to the laundry or the washer, or result in water leakage.
- 30 Make sure that the faucet is turned off when the washer is not being used.
- 31 Make sure that the water supply hose connectors are properly tightened. Failure to do so may result in property damage or injury.
- 32 Open the faucet and check if the water supply hose connector is firmly tightened and that there is no water leaking before using the product. If the water supply hose connectors are loose, it may result in water leakage.
- 33 Do not stand on top of the appliance or place objects (such as laundry, lighted candles, lighted cigarettes, dishes, chemicals, metal objects, etc.) on the appliance. This may result in electric shock, fire, problems with the product, or injury.
- 34 Do not operate the appliance with wet hands. This may result in electric shock.

SAFETY and PRECAUTIONS

- 35 Do not spray volatile material such as insecticide onto the surface of the appliance. As well as being harmful to humans, it may also result in electric shock, fire, or problems with the product.
- 36 Do not place an object that generates an electromagnetic field near the washer. This may result in injury due to a malfunction.
- 37 Since the water drained during a high temperature wash or drying cycle is hot, do not touch the water. This may result in burns or injury.
- 38 Do not wash, spin, or dry water-proof seats, mats, or clothing.
- 39 Do not wash thick, hard mats even if the washer mark is on the care label. This may result in injury or damage to the washer, walls, floor, or clothing due to abnormal vibrations.
- 40 Do not place any non-laundry objects, such as shoes, food waste, or animals into the washer. This can cause abnormal vibrations that can damage the washer, and, in the case of pets, cause severe injury or death.
- 41 Do not press the buttons using sharp objects such as pins, knives, or fingernails. This may result in electric shock or injury.
- 42 Do not wash laundry contaminated by oils, creams, or lotions usually found in skin-care shops or massage clinics. This may result in the rubber seal becoming deformed and water leakage.
- 43 Make sure that the water inlet pipe is connected and the tap is opened before washing clothes.
- 44 Do not leave metal objects (safety pins, hair pins, and so on) or bleach in the tub for long periods of time. This may cause the tub to rust.
 - If rust appears on the surface of the tub, apply a neutral cleansing agent to the surface and use a sponge to clean it. Never use a metal brush.
- 45 Do not use hot water from water cooling/heating devices. This may result in problems with the washer.
- 46 Do not use natural hand-washing soap in the washer. If it hardens and accumulates inside the washer, it may cause problems with the product, discoloration, rust, or bad odors.
- 47 If using a washing net with this machine (not provided), do not wash laundry items such as bedding in the washing net. Doing so may result in injury due to abnormal vibrations. Place only smaller items, such as lace socks and lingerie, in the washing net.
- 48 Do not use hardened powdered detergent. If it accumulates inside the washer, it may result in water leakage.
- 49 Do not wash throw rugs or doormats. Doing so may cause sand to accumulate inside the washer, resulting in mechanical problems.

Grounding/Earthing

- 1 This appliance must be properly grounded.
- 2 Do not ground the appliance to a gas pipe, plastic water pipe, or telephone line.
 - Improper grounding may result in electric shock, fire, explosion, or problems with the product.
 - Never plug the power cord into a socket that is not grounded correctly. Make sure that the socket you use is grounded in accordance with local and national codes.

Choosing a Proper Location

- 1 Do not install this appliance near a heater or inflammable material.
- 2 Do not install this appliance in a humid, oily, or dusty location, or in a location exposed to direct sunlight or water (rain drops).
- 3 Do not install this appliance in a location where gas may leak. Failure to do so may result in electric shock or fire.
- 4 If the washer is moved to a new location, have it checked and re-installed by a qualified service technician. Failure to follow this warning may result in electric shock or fire.

INSTALLATION INSTRUCTIONS

Top-Load Washer

Features

Package contents

Make sure that the following items came with your washer:

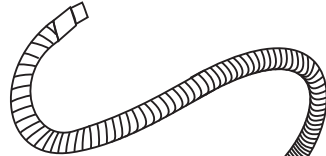

INSTALLATION INSTRUCTIONS

Main components

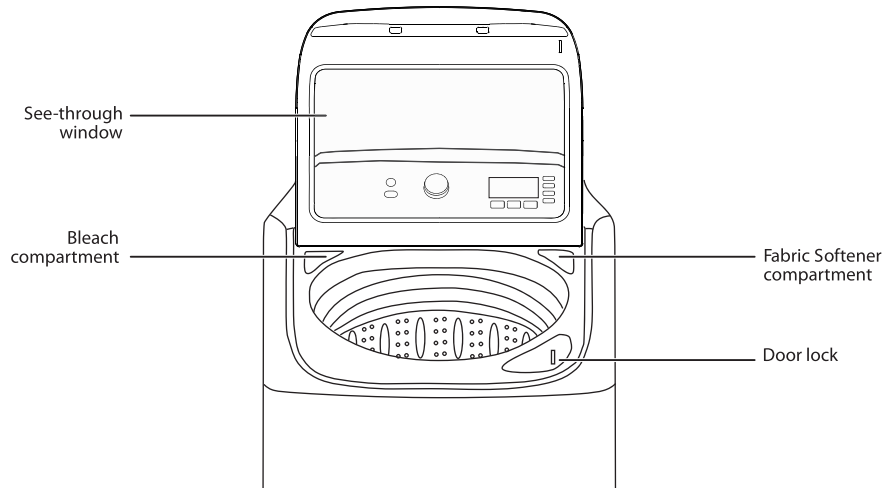
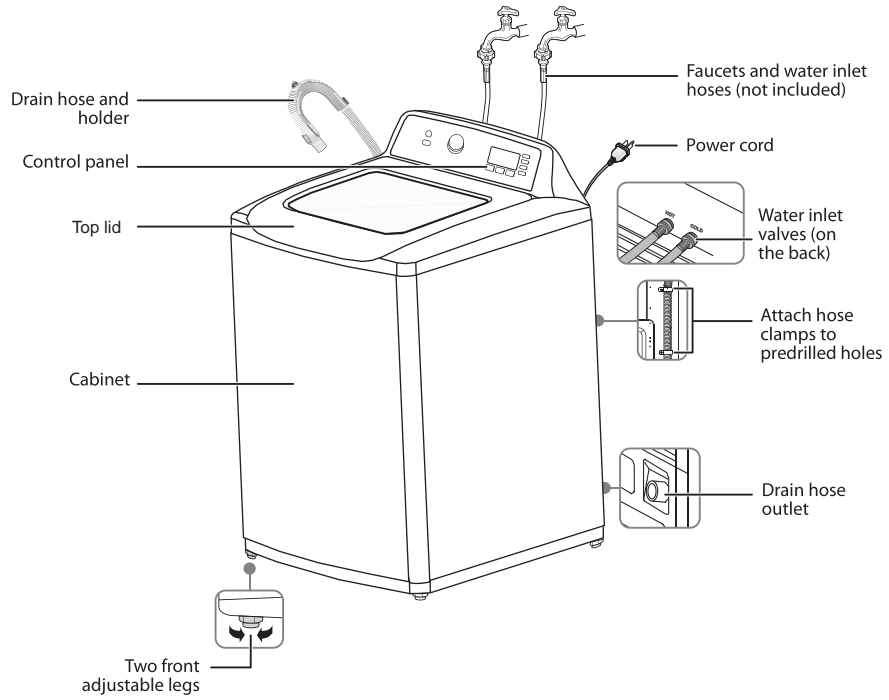

INSTALLATION INSTRUCTIONS

Top-Load Washer

Control panel

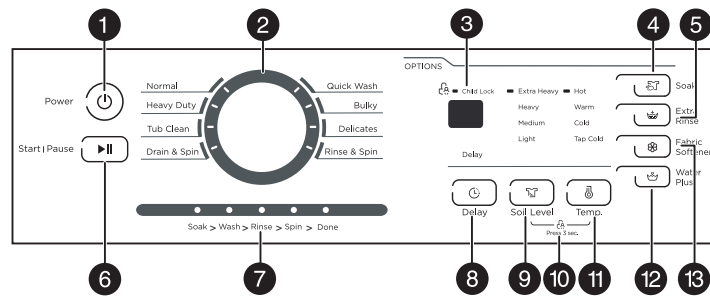

#	ITEM	DESCRIPTION
1	⏻/Power button	Press to turn on your washer. Press again to turn off your washer. If you leave your washer on and do not press the ▶ /Start Pause button within 10 minutes, your washer automatically turns off.
2	Cycle selector	Turn to select a wash cycle. The cycle you select determines the wash pattern for the cycle. For more information, see Washer options and settings on page 25.
3	Digital display	<ul style="list-style-type: none"> The initial display is the total time for the cycle you select. While your washer is running, the display shows the cycle process and time remaining in the cycle. Note: The time shown is an estimate based on normal operating conditions. External factors (such as the load size, room temperature, incoming water temperature, and water pressure) can affect actual time. If you set a delay time for the start of the cycle, the display shows the time when the cycle will start.
4	Soak button	Press to select the Soak option. Press again to cancel. Select this option for heavily soiled items that need to soak to remove stains and heavy dirt. Soak occurs after the tub fills and detergent is added, but before the wash process. The agitator will rotate several times during the soak process.
5	Extra Rinse button	Press to add an extra rinse to the wash cycle. Press again to cancel.
6	▶ /Start Pause button	Press once to start the wash cycle. Press again to pause the cycle. If you pause the cycle, you can add or remove items, but you cannot change any settings. Press again to restart the cycle.
7	Cycle status lights	Light to indicate what part of the cycle your washer is in. For example, the Soak light turns on when your washer is in the Soak process.
8	Delay button	Press to select a time when you want the cycle to begin. You can set the time up to 24 hours in advance in one-hour increments. The display shows the time when the cycle will start. For more information, see Step 5: (Optional) Set a delayed start time on page 23.
9	Soil Level button	Press to select the soil level. Different soil levels result in different washing times and wash cycle settings. For more information, see Washer options and settings on page 25.
10	Child lock	Press and hold the Soil Level and Temp buttons at the same time for three seconds to turn on the child lock function. Press and hold these buttons again for three seconds to turn off the function. When the child lock function is turned on, the only button that works is the ⏻/POWER button and the Soil Level and Temp buttons you use to turn off the child lock.
11	Temp button	Press to select the washing water temperature. The rinse water temperature is always cold.
12	Water Plus button	Press once to increase one higher water level. Press again to cancel this function. If the water level is already set to the highest, the level will not change.
13	Fabric Softener button	Add liquid fabric softener to the fabric softener compartment, then press this button. The fabric softener is added to the cycle at the correct time.

INSTALLATION INSTRUCTIONS

Unpacking your washer

Warning

- Packing materials can be dangerous to children. Keep all packing materials (plastic bags, polystyrene, and so on) well out of the reach of children.
- Do not operate your washer on the foam base cushion. Doing so will result in serious vibration, which could cause equipment damage or result in physical injury.

- Remove the packing box and lift the washer up and away from the foam base cushion. Open the lid of the washer to take out all accessories including the protective foam.

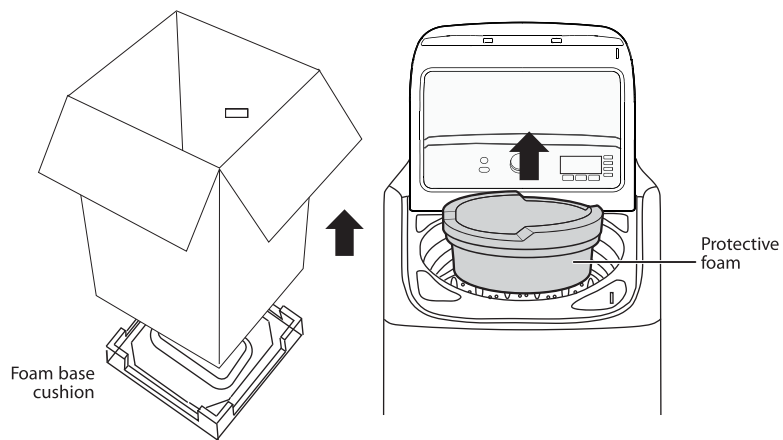

INSTALLATION INSTRUCTIONS

Top-Load Washer

Choosing a location

Warning

- Do not install your washer in areas where water may freeze, because your washer always retains some water in its water valve, pump, and hose areas. Frozen water can damage the belts, pump, hoses, and other components.
- Never install on a platform or weakly supported structure.

For best performance, you must install your washer on a solid, level floor. Wooden floors may need to be reinforced to minimize vibration or unbalanced load situations. Carpeting and soft tile surfaces can contribute to excessive vibration, which can cause your washer to move slightly during the spin cycle.

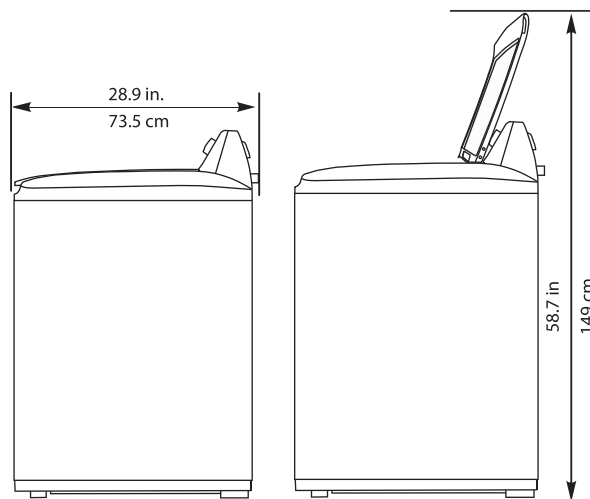
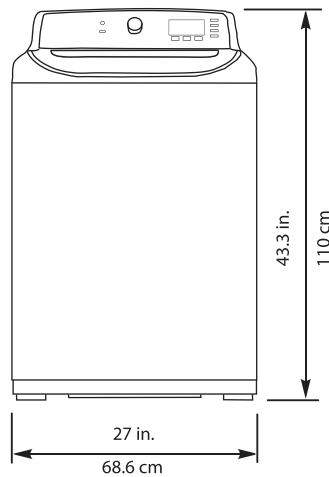
Washer dimensions and installation measurements

INSTALLATION INSTRUCTIONS

If you install your washer in an alcove or closet, the front of the closet must have two unobstructed air openings for a combined minimum total area of 72 sq.in. (465 sq.cm) with a minimum clearance of 3 in. (7.6 mm) at the top and bottom. A slatted door with equivalent space clearance is acceptable.

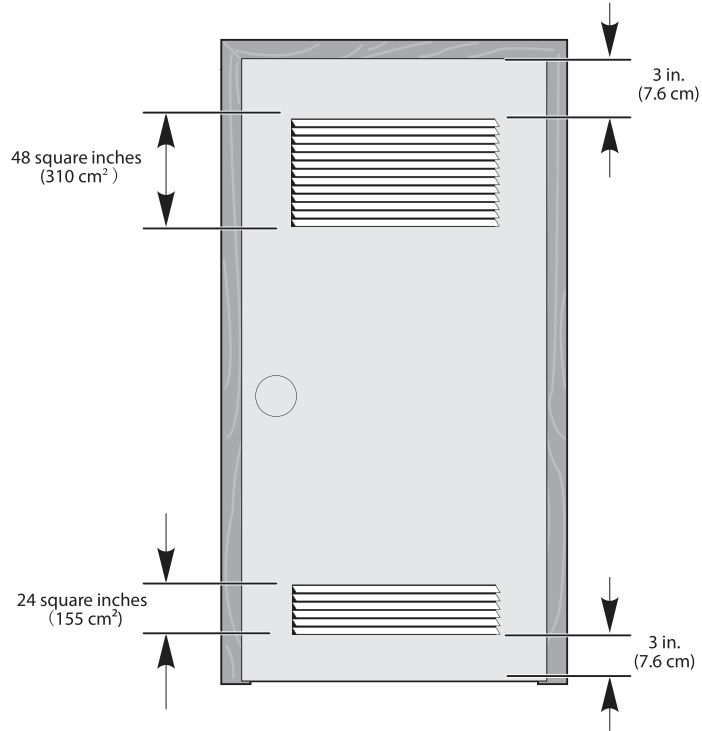

INSTALLATION INSTRUCTIONS

Top-Load Washer

Installing in an alcove or closet

Minimum clearances between your washer and adjacent walls or other surfaces are:

- **Either side:** 1 in. (2.5 cm)
- **Rear:** 6 in. (15.2 cm)
- **Closet Front:** 2 in. (5.1 cm)
- **Top:** 24 in. (61 cm)
- **Gap between the end of water valve and the wall:**
 - **Case 1:** If you connect the supply hose **after** you install your washer: Over 3.9 in. (10 cm)
 - **Case 2:** If you connect the supply hose **before** you install your washer: Over 2.8 in. (7 cm)

If you install your washer and dryer side-by-side in a closet, the closet front must have an unobstructed air opening of at least 72 square inches (465 square cm).

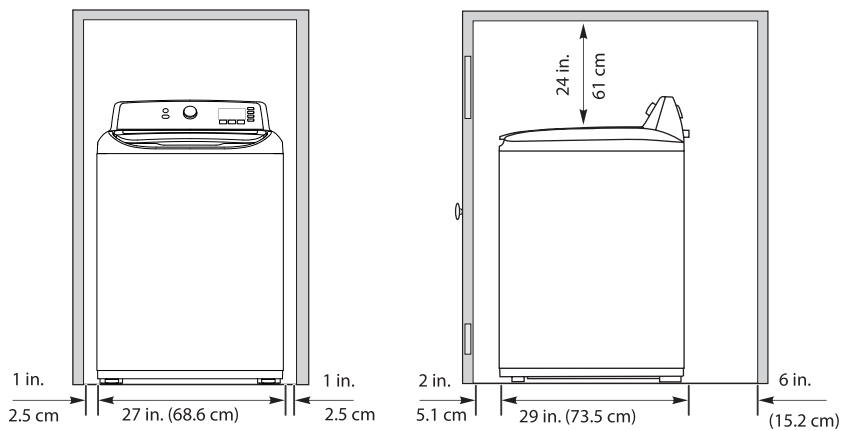

Electrical requirements

⚠ Warning

To reduce the risk of fire, electric shock, or injury to persons, read the IMPORTANT SAFETY INSTRUCTIONS before operating this appliance.

Use a 120 Volt, 60Hz, 15 amp fuse or circuit breaker. We recommend an individual branch circuit that serves only your washer.

⚠ Warning

Never use an extension cord.

Electrical grounding is required for your washer.

You must ground your washer. In the event of a malfunction or breakdown, grounding reduces the risk of electric shock by providing a path of least resistance for the electric current.

Your washer is equipped with a power cord with a three-pronged grounding plug for use in a correctly installed and grounded outlet.

INSTALLATION INSTRUCTIONS

The outlet must be correctly installed and grounded in accordance with all local codes and ordinances.

Warning

- You are responsible for providing adequate electrical services for your washer.
- An incorrectly connected equipment-grounding conductor can increase the risk of electrical shock. Check with a qualified electrician or serviceman if you are not sure whether your washer is grounded correctly.
- Do not modify the power cord plug that came with your washer. If the plug does not fit the outlet, have the correct type of outlet installed by a qualified electrician.
- To prevent unnecessary risk of fire, electrical shock, or personal injury, all wiring and grounding must be done in accordance with the National Electrical Code ANSI/FNPA, No.70 Latest Revision and local codes and ordinances.
- Never connect the ground wire to plastic plumbing lines, gas lines, or hot water pipes.

Water requirements

To fill your washer in the correct amount of time, the water pressure needs to be between 14 and 116 psi (100 to 800 kPa).

If the water pressure is less than 14 psi (100 kPa):

- The water valve may fail or may not shut off completely.
 - The time it takes to fill your washer may be longer than the time your washer controls allow. Your washer will turn off and report an error. A time-limit is built into the controls to prevent flooding in your home if a hose becomes loose.
 - Water inlet hoses must be purchased separately. You can buy inlet hoses in various lengths up to 8 ft. (240 cm).
- To avoid the possibility of water damage:
- Make sure that the water faucets are easily accessible.
 - Turn off the faucets when you are not using your washer.
 - Periodically check to make sure that water is not leaking from the water hose fittings.

Drainage requirements

- The recommended height for the drain standpipe is 48 in. (122 cm).
- The drain hose must be routed through the drain hose clip to the standpipe.
- The standpipe must be large enough to accept the outside diameter of the drain hose (1.46 in. / 3.7 cm).

INSTALLATION INSTRUCTIONS

Top-Load Washer

Installing your washer

Tools you will need



Step-by-Step instructions

Step 1: Select a location

Before you install your washer, make sure that the location:

- Is a hard, level surface without carpeting or soft flooring that can obstruct ventilation.
- Is away from direct sunlight.
- Has adequate ventilation.
- Is not exposed to freezing temperatures (32° F or 0° C).
- Is away from heat sources such as oil or gas.
- Has enough space so that the washer does not rest on its power cord.

Step 2: Connect the water hoses

Note

The water supply hoses are not supplied with your washer and must be purchased separately.

Caution

- Use new water supply hoses. Using old hoses can result in leakage or overflow that can damage your property.
- Do not connect multiple water supply hoses together to increase the length of the hose. Hoses connected this way can leak and cause electrical shock. If a hose is too short, replace the hose with a longer, high-pressure hose.

- 1 Make sure that there are rubber washers inside the fittings at both ends of each new water hose. Installing the water supply hoses without rubber washers can cause water leakage.

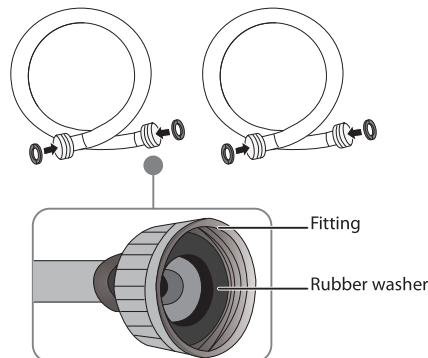

INSTALLATION INSTRUCTIONS

- 2 Tighten the hose and faucet fittings by hand until they are snug, then tighten them an additional two-thirds of a turn with pliers or a wrench. Pull the water supply hoses downwards to make sure that they are connected securely.

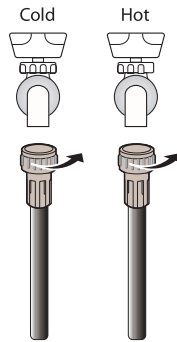

Caution

Do not overtighten the fittings or apply tape or sealant to the faucets or water supply intakes. This can damage the fittings.

- 3 Place the unconnected ends of the hoses into a bucket and turn on the faucets connected to the water supply hoses for 10 or 15 seconds to remove any foreign substances. Turn off the faucets.

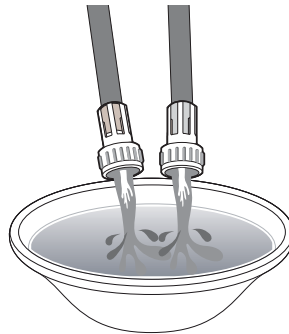

INSTALLATION INSTRUCTIONS

Top-Load Washer

- 4 Connect the ends of the water supply hoses to the water supply intake connections at the top of the washer. Make sure that the rubber washers are in place. The water supply hose connected to the hot faucet must be connected to the hot water supply intake and the water hose connected to the cold faucet must be connected to the cold water supply intake.

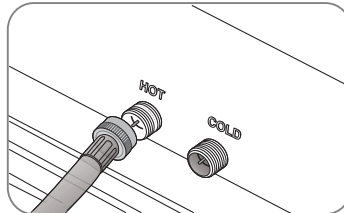

Notes

- If you do not want to use the hot water supply hose, insert a water intake cap into the hot water supply intake hole. In this case, you must select the **Tap Cold** option for the water temperature.
- No intake cap is provided with your washer. It must be purchased separately.

- 5 Tighten the fittings by hand until they are snug, then tighten them an additional two-thirds of a turn with a wrench.

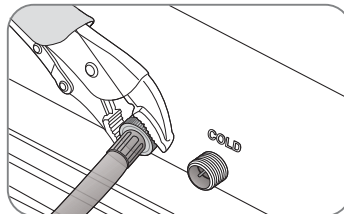

Caution

- Do not overtighten the fittings or apply tape or sealant to the faucets or water supply intakes. This can damage the fittings.
- Make sure that the water supply hoses are not twisted or bent. A bent or twisted hose can leak and cause an electric shock due to the water leakage. To ensure the correct water usage, connect both hot and cold water faucets. If either or both are not connected, an error code could occur.

- 6 Turn on the hot and cold water supplies and check all the water supply intake connections and the faucets for water leaks.

INSTALLATION INSTRUCTIONS

Step 3: Connect the drain hose

⚠ Caution

- Failure to slide the drain hose completely over the washer's drain pipe may result in water leakage.
- Failure to move the clamp or hoop onto the washer's drain pipe will result in water leakage.

- 1 Find the end of the drain hose that has the clamp, then slide the clamp away from the end of the hose.

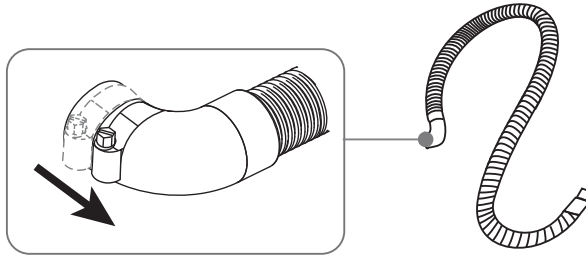

- 2 Insert the drain hose with the clamp onto the washer's drain pipe. Make sure that the drain hose completely covers the end of the drain pipe.

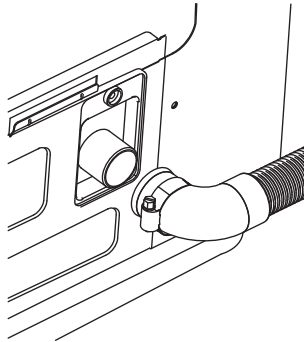

- 3 Move the clamp toward the drain pipe outlet. Tighten the clamp with a flat blade screwdriver.

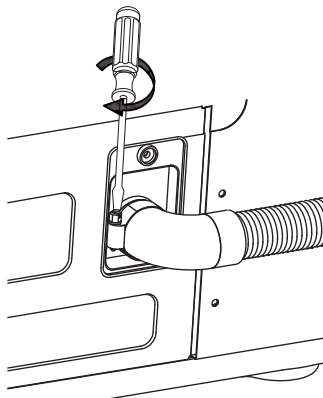

INSTALLATION INSTRUCTIONS

Top-Load Washer

- 4 Fasten the drain hose to the washer frame at the indicated locations with the hose clamps (2) provided, using a Phillips screwdriver.

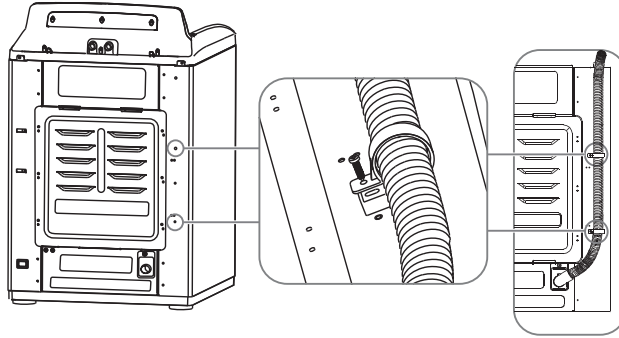

- 5 Position the other end of the drain hose (the loose end) in one of the following ways:

Caution

Make sure that the connection between the drain hose and the wash basin, standpipe, or laundry tub is not airtight.

- **Over the edge of a wash basin** - Secure the guide to the side of the basin wall with a hook, tape it, or tie it with a piece of cord to prevent the drain hose from moving.

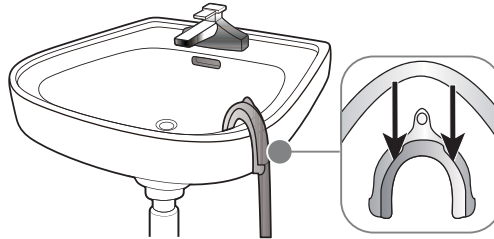

- **In a standpipe** - The standpipe must be no shorter than 39-in. (99 cm) and no longer than 96-in. (244 cm).

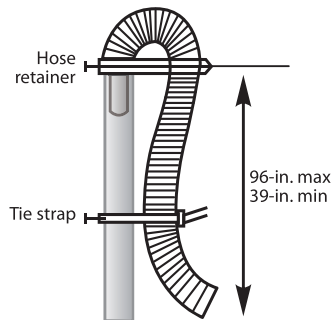

INSTALLATION INSTRUCTIONS

• **In a laundry tub** - The laundry tub must be no shorter than 39-in. (99 cm) and no higher than 96-in (244 cm) maximum.

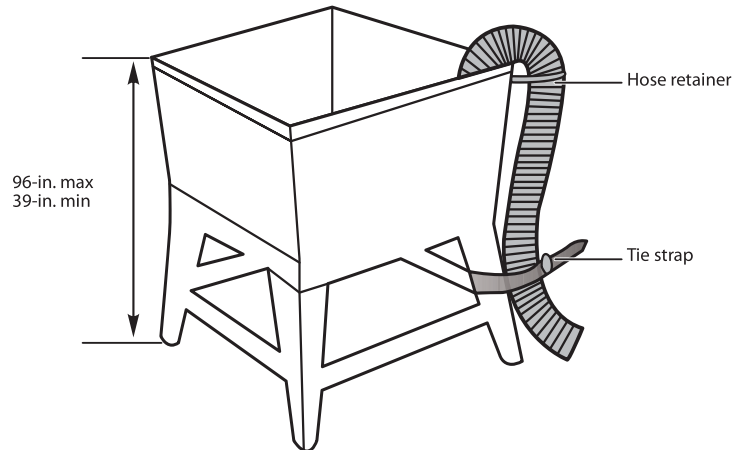

Step 4: Level your washer

⚠ Caution

Do not use your washing machine without leveling. If your washer is not level, it may:

- Vibrate excessively which can cause your washer to malfunction
- Make excessive noise.
- Indicate error codes E3, E4 or E5 when the washer is running.

Extend the leveling feet only as much as is necessary. If the feet are extended too much, your washer may vibrate.

Determine if the washer is level by checking the position of the tub or by using a level.

- 1 Slide the washer into position.
- 2 Open the lid of the washer, then pour water into the tub to the leveling circle. If the washer is level the water will touch the leveling circle all the way around. If the washer is not level, the water will only touch part of the leveling circle.

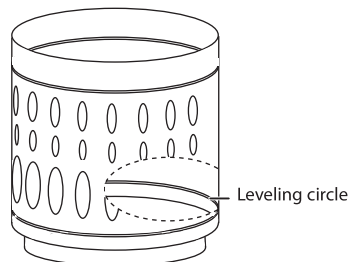

Add water to the washer until it reaches the leveling circle. If the washer is level, the water will touch the leveling circle all the way around. If it's not level, it will only touch part of the leveling circle.

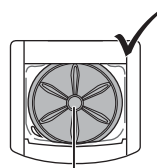

Washer is level - the water touches the leveling circle all the way around.

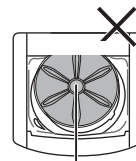

Washer not level - the water does not touch the leveling circle all the way around.

INSTALLATION INSTRUCTIONS

Top-Load Washer

- 3 If your washer is not level, carefully tilt your washer just enough to adjust the leveling feet on the bottom front of your washer. Extend the feet only as much as is necessary. If the feet are extended too much, your washer may vibrate.

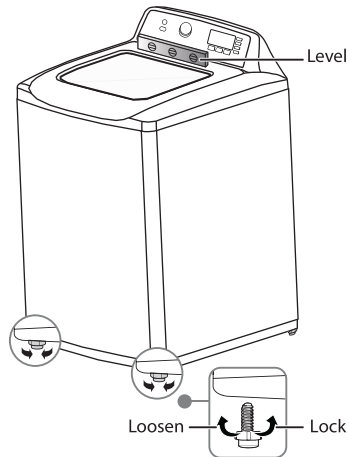

Step 5: Power your washer

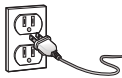

Plug the power cord into a well-grounded, 3-prong, 120 Volt 60Hz approved electrical outlet, protected by a 15-amp fuse or comparable circuit breaker. Your washer is grounded through the third prong of the power cord.

Step 6: Run a test cycle

Run a test cycle to make sure that your washer is properly installed.

- 1 Load about 6 pounds (2.7 kg) of laundry into the tub.
- 2 Press the **Power** button to turn on your washer.
- 3 Turn the cycle selector to select the **Rinse & Spin** cycle.
- 4 Press the **Start/Pause** button to start the test cycle. Your washer should not rock or vibrate excessively when water fills the tub, or when washing or spinning. The washer should drain well during the spin cycle.

⚠ Caution

- If you detect any water leaks while the washer is filling or draining, check the water connections. See [Step 2: Connect the water hoses](#) on page 15 or [Step 3: Connect the drain hose](#) on page 18.
- If the washer rocks and/or vibrates excessively, level it again. See [Step 4: Level your washer](#) on page 20.

Using your washer

Washing a load of laundry

WARNING – To reduce the risk of fire, electric shock, or injury to persons, read the IMPORTANT SAFETY INSTRUCTIONS before operating this appliance.

Selecting a detergent

Your washer is designed to use high efficiency (HE) detergents.

- For the best cleaning results, use an HE detergent. We recommend that you do not use a regular detergent. HE detergents contain suppressors that reduce or eliminate suds. When fewer suds are produced, the load tumbles more efficiently and cleaning is maximized.
- Reducing the amount of detergent may reduce the quality of cleaning. Make sure that you:
 - Pre-treat stains
 - Sort carefully by color and soil level
 - Avoid overloading

Step 1: Turn on your washer

Press the **Power** button to turn on your washer. Your washer's initial settings are:

- **Normal** on cycle selector with -- displayed on the digital display
- **Medium** for the **Soil Level**
- **Warm** for the **Wash Temp**

Step 2: Load your washer

Caution

Before loading your laundry, make sure that you remove coins, keys, and other hard objects, and close zippers. These items may damage clothes.

- 1 Sort laundry by fabric type, soil level, color, and load size. See [Fabric Care Chart](#) on page 29.
- 2 Fill the tub with dry, unfolded clothes. Load the tub no more than 3/4 full.

Note

- Overloading may reduce washing efficiency, cause excess wear, and possibly cause creasing or wrinkling of the load.
- Wash delicate items such as bras, hosiery, and other lingerie on the **Delicates** cycle with similar lightweight items.
- When washing big, bulky items (such as rugs or pillows) or a few smaller items (such as stuffed toys or one or two sweaters) that do not fill the tub completely, add a few towels to improve spin performance.
- Always use the **Bulky** cycle for bulky items.
- When washing heavily soiled loads, do not overload your washer to ensure good cleaning results.

Step 3: Add detergent and additives to the tub/compartments

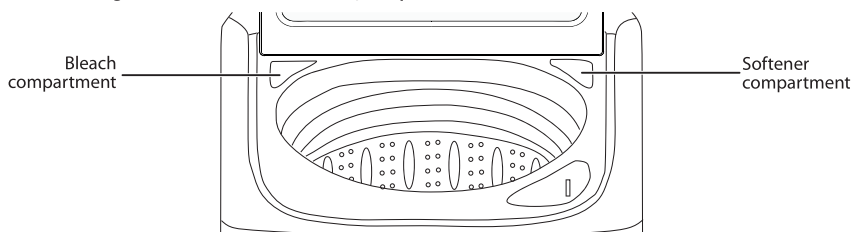

Loading the liquid or powder detergent

- 1 Pour the recommended amount of laundry detergent directly into the tub before starting your washer.
- 2 If you are using color-safe bleach, add it with the detergent to the tub.

Note

- When adding color-safe bleach with detergent, both laundry products should be in the same form (liquid).

OPERATING INSTRUCTIONS

Top-Load Washer

Loading the bleach compartment (liquid bleach only)

- Add chlorine bleach to the bleach compartment. Do not over-fill the compartment.
- There is no water inlet to the bleach dispenser, so the bleach will directly load into the tub when you pour it in.

⚠ Caution

- Avoid splashing or over-filling the compartment.
- Never pour undiluted liquid chlorine bleach directly onto the load or into the tub. Doing so can damage fabrics, by weakening of the fibers or stripping the color.

Note

Do not pour color-safe bleach into the bleach compartment. Instead, add it to the detergent compartment.

Loading the fabric softener compartment

- Pour the recommended amount of liquid fabric softener into the softener compartment. The dispenser automatically releases liquid fabric softener at the correct time during the rinse cycle.

⚠ Caution

- Use the softener compartment **ONLY** for liquid fabric softeners.
- Do not use the Downy Ball® in the fabric softener compartment.
- Do not use liquid fabric softener that is too sticky as it may not mix with the water sufficiently.
- Be sure to select the Fabric Softener option when using fabric softener so that it is released in the rinse portion of the cycle.

Step 4: Select the appropriate cycle and options for the load

- 1 Turn the cycle selector to select a washing cycle. For information on wash cycles, see [Washer options and settings](#) on page 25.



- 2 **Optional:** Use the control panel buttons (like **Fabric Softener**) to customize the washing cycle. For descriptions of buttons, see [Control panel](#) on page 9. For information about which buttons are available for each cycle type, see [Washer options and settings](#) on page 25.

Step 5: (Optional) Set a delayed start time

You can program a wash cycle, then set a time when you want a wash cycle to begin.

- 1 Press the **Delay** button to turn on the delay start time function.

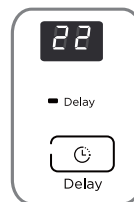

- 2 Press the **Delay** button repeatedly to select the delay time you want. The delay start time, in hours, will be shown on the display, in sequence, from **0** to **24**, then back to **0**. You can also press and hold the **Delay** button to quickly adjust the time until the desired time appears on the display.

OPERATING INSTRUCTIONS

- 3 If you want to change the wash cycle settings while you are setting the delay start time, turn the cycle selector. To return to setting the delay start time function, repeat Steps 1 and 2.

Notes

- Once the number of delay hours is reached by pushing the **Delay** button, release the button for three seconds and it will be set. The **Delay** light will remain on.
- After the delay time is set, if you wish to change the delay setting, press the **Delay** button again until the desired hour is reached. Release the button for three seconds and it will be set.
- If you decide to cancel the delay setting, you can either turn the cycle selector or push the **Delay** button until **0** is reached.
- Ideally, you should set your cycle before setting the **Delay**, because turning the cycle selector after the **Delay** is set cancels the delay.
- **The Delay Start Time cannot be changed after the program has started.**

- 4 To cancel the delay start time function before you save the setting, press the **Delay** button until **0** appears on the display, or turn the cycle selector knob.

Important

You can change settings or cancel the delay start time function anytime before you press the **▶II/Start Pause** button by turning the cycle selector. The delay start time cannot be changed after you press the **▶II/Start Pause** button.

If you pressed the **▶II/Start Pause** button, you can cancel the delay start time function by pressing the **⏻/Power** button to turn off your washer, then pressing the **⏻/Power** button again to turn it back on.

Step 6: Start your washer

- 1 Press the **▶II/Start Pause** button.

Note

If you have not set a delayed start time or if the delay time has expired, your washer starts the cycle and the **Wash** light turns on.

As your washer moves from stage to stage in the wash cycle, the related light turns on (such as **Rinse** or **Spin**).

If you set a delayed start time, the **Delay** light turns on and your washer starts counting down the start time.



- 2 If you need to pause the cycle (for example to add or remove items or adjust the load), press the **▶II/Start Pause** button, then open the lid. Your washer stops. When you are ready to resume washing, close the door, then press the **▶II/Start Pause** button.

Step 7: Unload your laundry

When the wash cycle is complete:

- The **Done** light turns on
- Your washer beeps six times and flashes **11, 22, 33, 44, 55, 66** after the cycle is done.
- Your washer unlocks the lid



- Open the lid and remove the laundry.

OPERATING INSTRUCTIONS

Top-Load Washer

Setting the child lock

Your washer has a child lock function to prevent children from playing with your washer. When you turn on the child lock, the only buttons that work are the **Power** button and the **Soil Level** and **Temp** buttons you use to turn off the child lock.

- 1 Press and hold both the **Soil Level** and **Temp** buttons for three seconds. The child lock light turns on.

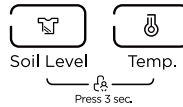

- 2 To turn off the child lock, press and hold both the **Soil Level** and **Temp** buttons for three seconds.

Note

- If your washer is not turned on, the child lock can still remain set. Press the **Power** button, turn on the child lock function, then press the **Power** button to turn off your washer. When you want to use your washer, you need to turn off the lock function.
- If you turn on the child lock function while the washer lid is open, **E3** appears on the display. If you do not close the lid within 20 seconds, your washer sounds an alarm, displays **CL**, and drains all the water in the tub. To clear the alarm, press the **Power** button to turn off your washer.

Washer options and settings

- Maximum load weight = 16.60 lbs. (7.53 kg) (Dry clothes)
- Bolded options are initial settings. • (dots) indicate optional functions you can select.

Cycle	Fabric type	Soil level options	Temp options	Delay	Soak	Extra rinse	Fabric softener	Water Plus
Normal	Cotton, Linen Towels, Shirts Sheets, Jeans Mixed loads	Extra Heavy Heavy Medium Light	Hot Warm Cold Tap Cold	•	•	•	•	•
Heavy Duty	Heavily soiled cotton fabrics	Extra Heavy Heavy Medium	Hot Warm Cold Tap Cold	•	•	•	•	•
Tub Clean	See page 22	Extra Heavy	Hot	•				
Drain&Spin								
Rinse & Spin			Tap Cold	•			•	•
Delicates	Dress shirts Blouses Nylons Sheer/lacy	Medium Light	Hot Warm Cold Tap Cold	•	•	•	•	•
Bulky	Large items like blankets and comforters	Extra Heavy Heavy Medium Light	Hot Warm Cold Tap Cold	•	•	•	•	•
Quick Wash	Lightly soiled and small loads	Medium Light	Hot Warm Cold Tap Cold	•	•	•	•	•

OPERATING INSTRUCTIONS

Maintaining your washer

Caution
Turn off the water faucets after final use. This shuts off the water supply to your washer and prevents the possibility of damage from escaping water.

Cleaning the exterior

- Use a soft cloth to wipe up all detergent, bleach, or other spills as they occur.

Cleaning the interior

- Clean the interior of your washer periodically to remove any dirt, soil, odor, mold, mildew, or bacterial residue that may remain in your washer as a result of washing clothes.
Failure to follow these instructions may result in unpleasant conditions, including odors or permanent stains in your washer or on your laundry.
- To remove hard water deposits, use a cleaner labeled "Washer safe".

Cleaning the control panel

- Clean with a soft, damp cloth. Do not use abrasive powders or cleaning pads.
- Do not spray cleaners directly on the panel. The control panel finish may be damaged by some laundry pre-treatment soil and stain remover products. Apply such products away from your washer and wipe up any spills or over-spray immediately.

Cleaning the bleach or softener compartment

- To remove laundry product residue, wipe with a damp cloth and towel dry.
- You can remove the bleach and softener compartments to clean them.

Cleaning the tub

The **Tub Clean** cycle is a self-cleaning cycle that removes the causes of odors that may occur inside your washer. We suggest cleaning the tub about once a month.

Caution
Never use the **Tub Clean** cycle when laundry is in your washer. This may damage the laundry or your washer.

- With the tub empty, add one cup of chlorine bleach to the bleach dispenser.
- Press the **Power** button.
- Turn the cycle selector to **Tub Clean**. When you select **Tub Clean**, the only options you can change is the **Delay** option.
- Press the **Start/Pause** button.

Storing your washer

You can damage your washer if you do not remove water from hoses and internal components before storage.

To prepare your washer for storage:

- Select the **Quick Wash** cycle and add bleach to the washer. Run your washer through the cycle without a load.
- Turn the water faucets off and disconnect the inlet hoses.
- Unplug your washer from the electrical outlet.

Caution
If the washer is stored in an area where freezing can occur or moved in freezing temperatures, follow these winterizing instructions to prevent damage to the washer:

- Turn off water supply faucets.
- Disconnect hoses from water supply and drain water from hoses.
- Plug electrical cord into a properly grounded electrical outlet.
- Add 1 gallon (3.8 L) nontoxic recreational vehicle (RV) antifreeze to empty wash tub. Close lid.
- Select the **Drain & Spin** cycle. Start the cycle and let the washer drain for 1 minute to drain out all the water. Not all of the RV antifreeze will be expelled.
- Stop the cycle, unplug electrical power cord, dry off tub interior and close the lid.
- Store washer in an upright position.
- To remove antifreeze from washer after storage, run empty washer through a complete cycle using detergent. Do not add wash load.

Troubleshooting

Caution
Do not try to repair your washer yourself. Doing so invalidates the warranty.

PROBLEM	SOLUTION
Washer does not start	<ul style="list-style-type: none"> Make sure that your washer is plugged in. Make sure that the lid is closed. Make sure that the water source faucets are open. Make sure that you press the Start/Pause button to start your washer. Before your washer starts to fill, it makes a series of clicking noises to make sure that the lid is locked and to do a quick drain. Make sure that the Child Lock is not activated. See Setting the child lock on page 25. Make sure that the Delay option is not turned on. See Step 5: (Optional) Set a delayed start time on page 23. Check the fuse or reset the circuit breaker.

USER MAINTENANCE INSTRUCTIONS

Top-Load Washer

PROBLEM	SOLUTION
No water or not enough water Detergent or softener is still in its compartment after the wash cycle is	<ul style="list-style-type: none"> • Make sure that both faucets are fully turned on. • Make sure that the water pressure is in the range listed in Water requirements on page 14. • Make sure that the water inlet hoses are not kinked. Straighten if necessary. • Disconnect the hoses and clean the screens. The hose filter screens may be clogged.
Washer vibrates or is too noisy	<ul style="list-style-type: none"> • Make sure that your washer is set on a level surface. If the surface is not level, adjust your washer's feet to level your washer. • Make sure that your washer is not touching any other object. • Make sure that the laundry load is balanced. • During the spin process, if clothes are piled to one side of the tub, your washer may stop because of the imbalance. Your washer tries up to three times to solve the problem automatically. If the washer cannot solve the problem, try to manually redistribute clothes inside the tub.
Washer stops	<ul style="list-style-type: none"> • Make sure that the power outlet is a working outlet. • Check the fuse or reset the circuit breaker. • Close the lid, then press the ▶ /Start Pause button to start your washer. For your safety, your washer does not spin unless the lid is closed. • Before your washer starts to fill, it makes a series of clicking noises to make sure that the lid is locked and to do a quick drain. • Sometimes your washer may pause between stages in the cycle. Wait to see if your washer starts again. • Disconnect the inlet hoses and clean the screens periodically. The hose filter screens may be clogged.
Lid is locked or will not open	<ul style="list-style-type: none"> • Press the ▶ /Start Pause button to pause the washer. You cannot open the lid if the washer is running. • After you pause the washer, it may take a few seconds for the lid lock to release. • If the lid is locked when your washer is not running, press the ⏻/Power button to turn on your washer. • If power fails while your washer is running, when power is restored, the lid unlocks. Your washer waits three minutes, then runs the rest of the cycle.
Washer does not drain or spin	<ul style="list-style-type: none"> • Check the fuse or reset the circuit breaker. • Close the lid, then press the ▶ /Start Pause button to start your washer. For your safety, your washer does not spin unless the lid is closed. • Make sure that the drain hose is not kinked. Straighten as necessary. • Make sure that the height of the drain hose is within specified limits. See Drainage requirements on page 14. • The pipes to your sewer system may be clogged. Contact a plumber or qualified repair professional.
The water temperature is not correct	<ul style="list-style-type: none"> • Make sure that you have selected the correct temperature. • Make sure that the water source faucets are fully opened. • Make sure that the hoses are connected to the correct faucet and water intake connections on your washer, then flush the lines. See Step 2: Connect the water hoses on page 15. • Disconnect the hoses and clean the screens. The hose filter screens may be clogged.
Load is too wet at the end of the cycle	<ul style="list-style-type: none"> • Use a high-efficiency detergent to reduce over-sudsing. See Selecting a detergent on page 22. • The load may be too small. Very small loads (one or two items) may become unbalanced and not spin out completely.
Water leaks	<ul style="list-style-type: none"> • Make sure that all hose connections are tight. See Step 2: Connect the water hoses on page 15 and Step 3: Connect the drain hose on page 18. • Make sure that the end of the drain hose is correctly inserted and secured to the drainage system. See Step 3: Connect the drain hose on page 18. • Avoid overloading. • Use a high-efficiency detergent to reduce over-sudsing. See Selecting a detergent on page 22.
Load has too many suds	<ul style="list-style-type: none"> • Use a high-efficiency detergent to reduce over-sudsing. See Selecting a detergent on page 22. • If you have "soft" water, reduce the amount of detergent. • For small or lightly soiled loads, reduce the amount of detergent.
Washer has an odor	<ul style="list-style-type: none"> • Periodically run a Tub Clean cycle to clean the tub. See Cleaning the tub on page 26. • Use a high-efficiency detergent to reduce over-sudsing. Excessive suds collect in nooks and crannies and cause odor. See Selecting a detergent on page 22. • Dry the interior of your washer after the total cycle has finished.

USER MAINTENANCE INSTRUCTIONS

PROBLEM	SOLUTION
Load has too many suds	<ul style="list-style-type: none"> Use a high-efficiency detergent to reduce over-sudsing. See Selecting a detergent on page 22. If you have "soft" water, reduce the amount of detergent. For small or lightly soiled loads, reduce the amount of detergent.
Washer has an odor	<ul style="list-style-type: none"> Periodically run a Tub Clean cycle to clean the tub. See Cleaning the tub on page 26. Use a high-efficiency detergent to reduce over-sudsing. Excessive suds collect in nooks and crannies and cause odor. See Selecting a detergent on page 22. Dry the interior of your washer after the total cycle has finished.

Understanding the error codes

Your washer is equipped with an automatic error-monitoring system to detect and diagnose problems at an early stage.

ERROR CODE	POSSIBLE CAUSE	SOLUTIONS
E1	Your washer takes more than 30 minutes to fill with water. After water finishes entering your washer, the water level has not changed in five minutes.	<ul style="list-style-type: none"> Make sure that the lid is not open. Make sure that water is not leaking. See No water or not enough water on page 26. Contact Midea service center.
E2	The unit takes more than 10 minutes to drain.	<ul style="list-style-type: none"> See Washer does not drain or spin on page 27.
E3	The lid is open. The washer is not level.	<ul style="list-style-type: none"> Close the lid. Level the washer. See "Step 4: Level your washer" on page 20.
E4	Your washer is out of balance more than three times in spin operation.	<ul style="list-style-type: none"> See Washer vibrates or is too noisy on page 27. Contact Midea service center.

ERROR CODE	POSSIBLE CAUSE	SOLUTIONS
E5	Your washer is not level. Impact switch failed.	<ul style="list-style-type: none"> Adjust the washer level refer to installation. If the situation continues, call Midea service center.
F2	The EEPROM failed.	<ul style="list-style-type: none"> Contact Midea service center.
F5	Load sensing failed.	<ul style="list-style-type: none"> Contact Midea service center.
F8	Water level sensor failed.	<ul style="list-style-type: none"> Contact Midea service center.
Fd	Lid lock failed.	<ul style="list-style-type: none"> Contact Midea service center.
C9	The PCB failed.	<ul style="list-style-type: none"> Contact Midea service center.
CL	The lid has been open for over 20 seconds with the Child Lock function activated.	<ul style="list-style-type: none"> Press the Power button to turn off your washer. Turn off the Child Lock function. See Setting the child lock on page 25. Contact Midea service center.

Specifications



































TYPE	CTW41N1AW
Dimensions (H x W x D)	43.3 in. x 27 in. x 28.9 in. (110 cm x 68.6 cm x 73.5 cm)
Weight	140 lbs. (63.5 kg)
Power	120V~/60Hz
Current draw	10A
Pulsator type	Impeller
Drum grain	Ellipse
Display type	LED
Display color	White
Motor	Series

USER MAINTENANCE INSTRUCTIONS

Top-Load Washer

Fabric Care Chart

The following symbols provide garment care direction. The Clothing care labels include symbols for washing, bleaching, drying and ironing, or dry cleaning when necessary. The use of symbols ensures consistency among garment manufacturers of domestic and imported items. Follow care label directions to maximize garment life and reduce laundering problems.

WASH CYCLE		SPECIAL INSTRUCTIONS		WARNING SYMBOLS FOR LAUNDERING	
	Normal		Line Dry/ Hang to Dry		Do Not Wash
	Permanent Press / Wrinkle Resistant / Wrinkle Control		Drip Dry		Do Not Wring
	Gentle/Delicates		Dry Flat		Do Not Bleach
	Hand Wash	HEAT SETTING			Do Not Tumble Dry
WATER TEMPERATURE**			High		No Steam (added to iron)
	Hot		Medium		Do Not Iron
	Warm		Low	DRYCLEAN	
	Cold		Any Heat		Dry Clean
BLEACH			No Heat/Air		Do Not Dry Clean
	Any Bleach (when needed)	IRON-DRY OR STEAM TEMPERATURES			Line Dry/ Hang to Dry
	Only Non-Chlorine (color-safe) Bleach (when needed)		High		Drip Dry
	Tumble Dry Cycle		Medium		Dry Flat
NORMAL			Low		For machine-washable wool. Loads should be under 8 pounds.
	Permanent Press/ Wrinkle Resistant/ Wrinkle Control				
	Gentle/ Delicates				

** The dot symbols represent appropriate wash water temperatures for various items. The temperature range for Hot is 105°-125°F/41°-52°C, for Warm 85°-105°F/29°-41°C and for Cold 60°-85°F/16°-29°C. (Wash water temperature must be a minimum of 60°F/16°C for detergent activation and effective cleaning.)

The clothes washer can not ensure these temperatures because the actual temperature of the water entering your washer depends on water heater settings and regional water supply temperatures. For example, cold water entering the home in the northern states during winter may be 40°F/4°C which is too cold for effective cleaning. In this situation, you will need to adjust the water temperature by selecting a warm setting, adding some hot water to the MAX FILL line, or using your Washer's heating option, if available.

Criterion™ Washer Warranty

Your product is protected by this warranty:

Warranty service must be obtained from Midea Consumer Services or an authorized Midea servicer.

Warranty

- One year full warranty from original purchase date, includes compressor, parts and labor only.

Midea, through its authorized servicers will:

- Pay all costs for repairing or replacing parts of this appliance which prove to be defective in materials or workmanship.

Midea is not responsible for:

- Diagnostics, removal, transportation and reinstallation cost required because of service.
- Costs of service calls that are a result of items listed under **NORMAL RESPONSIBILITIES OF THE CONSUMER****

Midea replacement parts shall be used and will be warranted only for the period remaining on the original warranty.

NORMAL RESPONSIBILITIES OF THE CONSUMER**

This warranty applies only to products in ordinary household use, and the consumer is responsible for the items listed below:

1. Proper use of the appliance in accordance with instructions provided with the product.
2. Routine maintenance and cleaning necessary to keep the good working condition.
3. Proper installation by an authorized service professional in accordance with instructions provided with the appliance and in accordance with all local plumbing, electrical and / or gas codes.
4. Proper connection to a grounded power supply of sufficient voltage, replacement of blown fuses, repair of loosened connections or defects in house wiring.
5. Expenses for making the appliance accessible for servicing.
6. Damages to finish after installation.

EXCLUSIONS

This warranty does not cover the following:

1. Failure caused by damage to the unit while in your possession (other than damage caused by defect or malfunction), by its improper installation, or by unreasonable use of the product, including without limitation, failure to provide reasonable and necessary maintenance or to follow the written Installation and Operating Instructions.
2. Products purchased "as-is" or refurbished are not covered by this warranty.
3. Service calls to repair or replace consumables such as handles, knobs and other cosmetic parts.
4. Product that has been transferred from its original owner.
5. Interior or exterior rust on the unit.
6. Damages caused by services performed by persons other than authorized Midea servicers; use of parts other than Midea replacement parts; obtained from persons other than such Midea customer service; or external causes such as abuse, misuse, inadequate power supply or acts of God.
7. Service calls resulting from improper installation of your product.
8. Service calls to instruct you on the use of your product.
9. Surcharges including, but not limited to, any after hour, weekend, or holiday service calls, tolls, ferry trip charges, or mileage expense for service calls to remote areas, including the state of Alaska.
10. If the unit is put to commercial, business, rental, or other use or application other than for consumer use, we make no warranties, express or implied, including but not limited to, any implied warranty of merchantability or fitness for particular use or purpose.
11. Product that has been removed outside the USA or Canada.
12. Products without original serial numbers or products that have serial numbers which have been altered or cannot be readily determined.

Note: Some states do not allow the exclusion or limitation of incidental or consequential damages. So this limitation or exclusion may not apply to you.

IF YOU NEED SERVICE

Keep your bill of sale, delivery slip, and other appropriate payment record.

The date on the bill established the warranty period should service be required.

If service is performed, it is your best interest to obtain and keep all receipts.

This written warranty gives you specific legal rights. You may also have other rights that vary from state to state.

Service under this warranty must be obtained by following these steps, in order:

1. Contact Midea Consumer Services or an authorized Midea servicer at 1-866-646-4332 or customerserviceusa@midea.com
2. If there is a question as to where to obtain service, contact our consumer relations Department.

Criterion™

Tarjeta de Registracion de producto

Es sencillo! Cumple y envia su Tarjeta de Registracion de Producto hoy!

Nombre

Dirección

Ciudad Estado Código postal

Teléfono (Opcional) / -

Dirección de E-mail (Opcional)

Donde Comprado

<input type="text"/>	<input type="text"/>	<input type="text"/>	<input type="text"/>	<input type="text"/>	<input type="text"/>
Numero de Modelo	Numero de Serie	Mes	Dia	Ano	
220250418	REV 11/04				Fecha de la compra

Porfavor devuelve su Tarjeta de Registracion de Producto hoy!

Criterion™

Product Registration Card

It's simple! Complete and mail your Product Registration Card today!

Name

Address

City State Zip

Phone (Optional) / -

E-mail Address (Optional)

Where Purchased

<input type="text"/>	<input type="text"/>	<input type="text"/>	<input type="text"/>	<input type="text"/>	<input type="text"/>
Model Number	Serial Number	Month	Day	Year	
220250418	REV 11/04				Date of Purchase

Please return your Product Registration Card today!

1-866-646-4332

Su producto está protegido por esta garantía:
Su producto está garantizado por Midea. Cualquier obligación de proporcionar servicio o repuestos establecida en esta garantía deberá ser cumplida por los Servicios al consumidor de Midea o por un representante autorizado de Midea.
Para comunicarse con un Representante de Servicio al Cliente, tenga la bondad de llamar por teléfono sin cargo alguno a Midea, al número:

Garantía

1-866-646-4332

Your product is protected by this warranty:
Your appliance is warranted by Midea. Any obligations for services and parts under this warranty must be performed by Midea Consumer Services or an authorized Midea service
To contact a Customer Service Representative, Call Midea TOLL FREE

Product Warranty

Product Warranty Card
Tarjeta de Garantía de Producto



Criterion™



Postage
Required.
Post Office will
not deliver
without proper
postage.

PLACE
STAMP
HERE

Criterion™



Product Support
Midea America Corp.
759 Bloomfield Ave., #386
West Caldwell, NJ 07006-6701

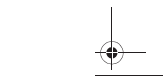
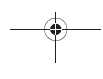

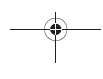

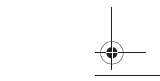
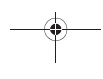



Criterion™

