

Criterion®

User's Manual

Refrigerator-Freezer

MODEL: CFDR286M4S

Before using your product, please read this manual carefully and keep it for future reference.

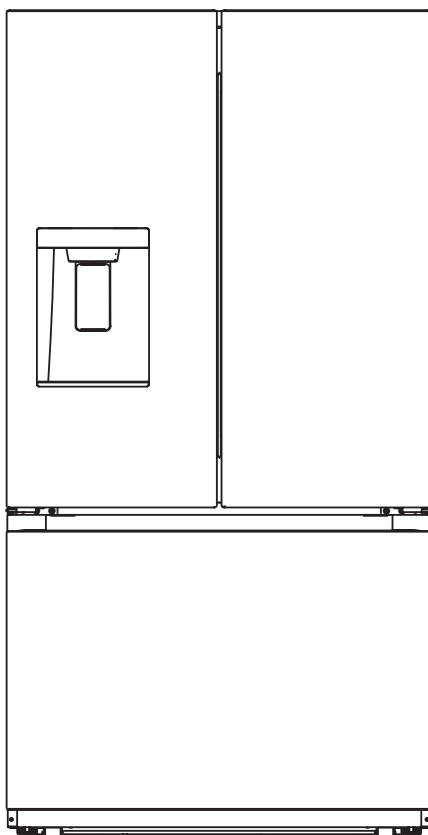

CONTENTS

SAFETY WARNINGS	03
PRODUCT OVERVIEW	05
PRODUCT INSTALLATION	06
OPERATION INSTRUCTIONS	12
CLEANING AND MAINTENANCE	18
TROUBLESHOOTING	22
WARRANTY	24

SAFETY WARNINGS



Warning: risk of fire / flammable materials

- This appliance is intended to be used in household and similar applications such as staff kitchen areas in shops, offices and other working environments; farm houses and by clients in hotels, motels and other residential type environments; bed and breakfast type environments; catering and similar non-retail applications.
- This appliance is not intended for use by persons (including children) with reduced physical, sensory or mental capabilities, or lack of experience and knowledge, unless they have been given supervision or instruction concerning use of the appliance by a person responsible for their safety.
- Children should be supervised to ensure that they do not play with the appliance.
- If the supply cord is damaged, it must be replaced by the manufacturer, its service agent or similarly qualified persons in order to avoid a hazard.
- Do not store explosive substances such as aerosol cans with a flammable propellant in this appliance.
- The appliance has to be unplugged after use and before carrying out user maintenance on the appliance.
- WARNING: Keep ventilation openings, in the appliance enclosure or in the built-in structure, clear of obstruction.
- WARNING: Do not use mechanical devices or other means to accelerate the defrosting process, other than those recommended by the manufacturer.
- WARNING: Do not damage the refrigerant circuit.
- WARNING: Do not use electrical appliances inside the food storage compartments of the appliance, unless they are of the type recommended by the manufacturer.
- WARNING: Please abandon the refrigerator according to local regulators for it use flammable blowing gas and refrigerant.
- WARNING: When positioning the appliance, ensure the supply cord is not trapped or damaged.
- WARNING: Do not locate multiple portable socket-outlets or portable power supplies at the rear of the appliance.
- Do not use extension cords or ungrounded (two prong) adapters.

- **WARNING:** Risk of child entrapment. Before you throw away your old refrigerator or freezer:
 - Take off the doors.
 - Leave the shelves in place so that children may not easily climb inside.
- The refrigerator must be disconnected from the source of electrical supply before attempting the installation of accessory.
- Refrigerant and cyclopentane foaming material used for the appliance are flammable. Therefore, when the appliance is scrapped, it shall be kept away from any fire source and be recovered by a special recovering company with corresponding qualification other than be disposed by combustion, so as to prevent damage to the environment or any other harm.
- The necessity that, for doors or lids fitted with locks and keys, the keys be kept out of the reach of children and not in the vicinity of the refrigerating appliance, in order to prevent children from being locked inside.
- **WARNING:** To avoid a hazard due to instability of the appliance, it must be fixed in accordance with the instructions.
- **WARNING:** Connect to potable water supply only.

PRODUCT OVERVIEW

Names of components

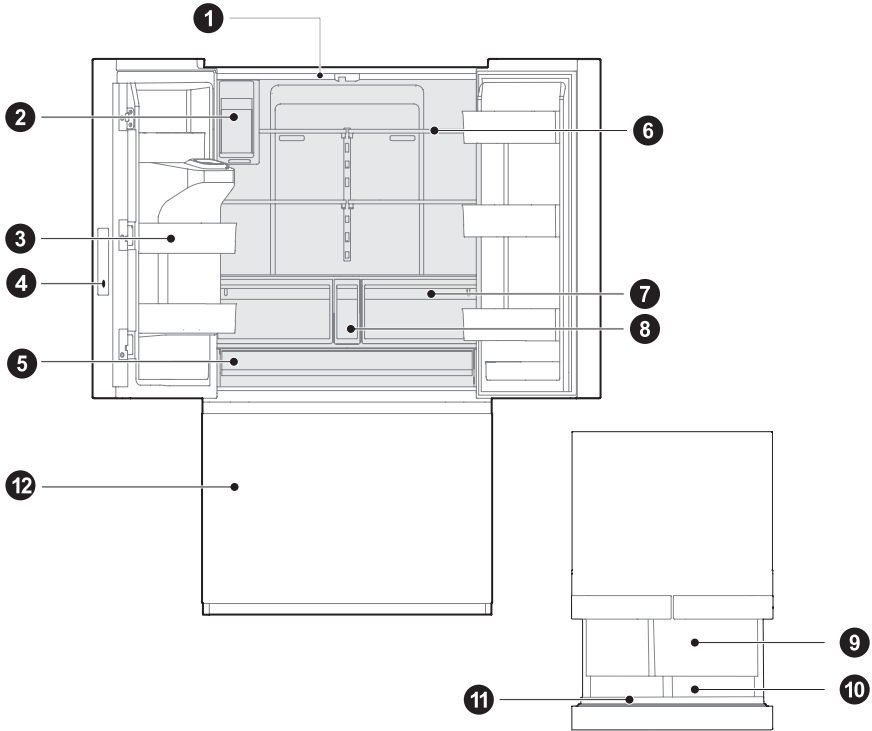

- | | | | |
|---|---------------|----|----------------------|
| 1 | LED lighting | 7 | Crisper drawer |
| 2 | Ice maker | 8 | Small drawer |
| 3 | Door tray | 9 | Upper freezer drawer |
| 4 | Control panel | 10 | Lower freezer drawer |
| 5 | Big drawer | 11 | Freezer tray |
| 6 | Shelf | 12 | Freezer drawer |

ATTENTION

- The picture above is only for reference. The actual configuration will depend on the physical product or statement by the distributor.
- Small drawers suggest placing items suitable for its size, such as smaller milk cartons.

PRODUCT INSTALLATION

Install Instruction

Finding a suitable location

- This refrigerator is designed to be free standing only, and should not be recessed or built-in.
- The refrigerator should be placed in a well-ventilated indoor place; the ground shall be flat and sturdy.
- Keep away from heat and avoid direct sunlight. Do not place the refrigerator in moist or watery places to prevent rust or reduction of insulating effect.

Dimensions and Clearances

- Too small of a distance from adjacent items may result in the degradation of freezing capability and increased electricity costs. Allow over 100 mm of clearance from each adjacent wall when installing the appliance.

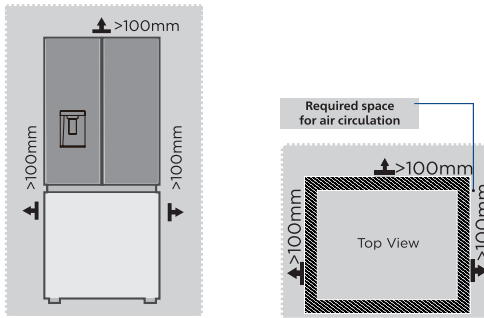

Providing a proper power supply

- Check your local power source. This refrigerator requires a 115 V, 60 Hz power supply.
- Use a receptacle that accepts the grounding prong. The power cord is equipped with a 3-prong (grounding) plug which mates with a standard 3-prong (grounding) wall outlet to minimize the possibility of electric shock hazard from this refrigerator.

CAUTION

The refrigerator should always be plugged into its own individual electrical outlet which has a voltage rating that matches the rating plate.

Never unplug your refrigerator by pulling on the power cord. Always grip the plug firmly and pull straight out from the outlet.

Start to use

- The refrigerator shall stay for half an hour before connecting power when it is firstly started.
- The refrigerator shall run 2 to 3 hours before loading fresh or frozen foods; the refrigerator shall run for more than 4 hours in summer in advance considering that the ambient temperature is high.

Space requirement diagram (when the door is open and when the door is closed).

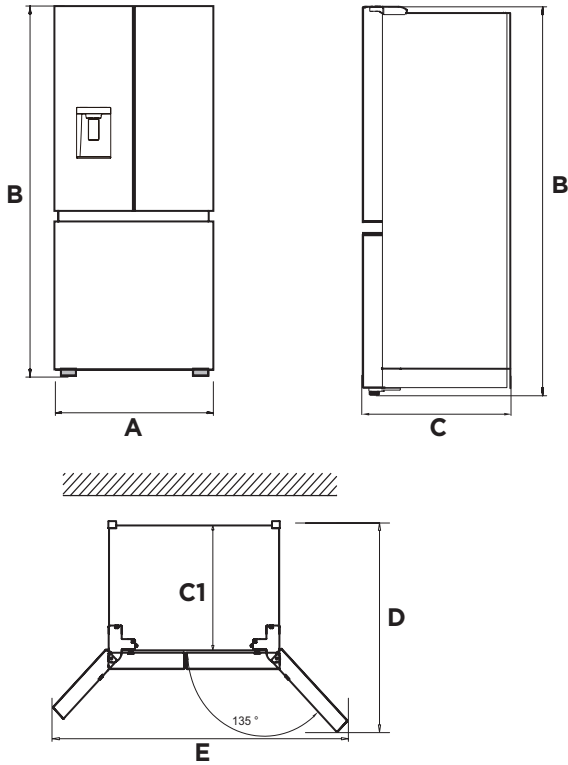

Width	Overall Height	Depth	Depth Only Cabinet	Depth doors open 135°	Width doors open 135°
A	B	C	C1	D	E
910	1775	862	745	1127	1596

Notice: All dimensions in mm

Installing the Water Line

Installing the Water Line

- Water line installation kits are available as an additional accessory from your dealer or at a local hardware store.
- First, shut off the main water supply line and turn the ice-maker off.
 - Locate the nearest cold water supply valve.
 - After connecting the water supply to the water valve, turn your main water supply back on and flush several gallons of water to clear the water supply line.

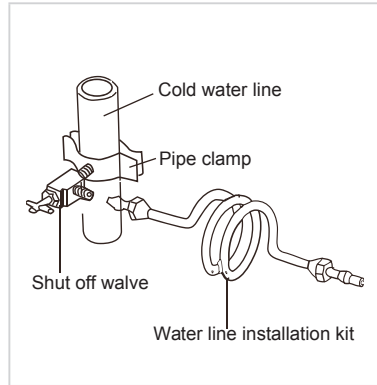

Connecting the Water Line to The Refrigerator

- There are several items that you need to purchase to complete this connection.
 - You will find these items sold as a kit at your local hardware store.
- First, close the main water supply and locate the nearest cold water line.
 - Second, connect the water valve to the cold water line.
 - Turn water valve on and check for any leakage.
 - When moving the refrigerator, you can hang the power cord on the power cord hook.

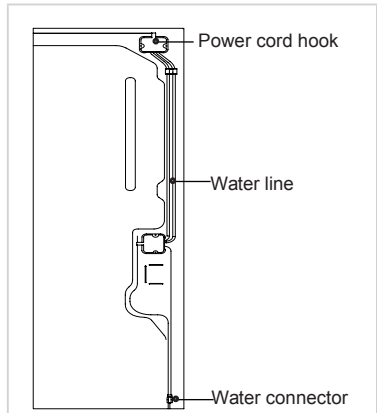

Connecting the Water Line to A Drinkable Water Source

- If your water line is not drinkable, please add an external water filter.
- If you must repair or disassemble the water line, cut off the plastic tubing to make sure you get a snug, leak-free connection.

ATTENTION

- The minimum inlet water pressure: 276kPa.
- The maximum inlet water pressure: 689kPa.
- Connect to potable water supply only new hose-sets supplied with the appliance are to be used and that old hose-sets should not be reused.

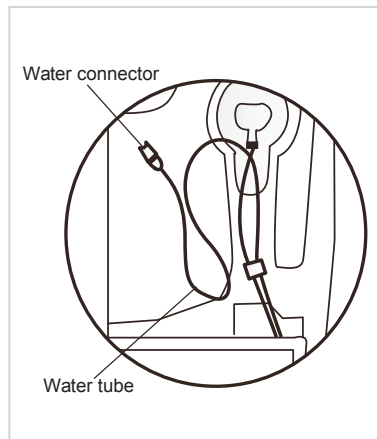

Installing Filter

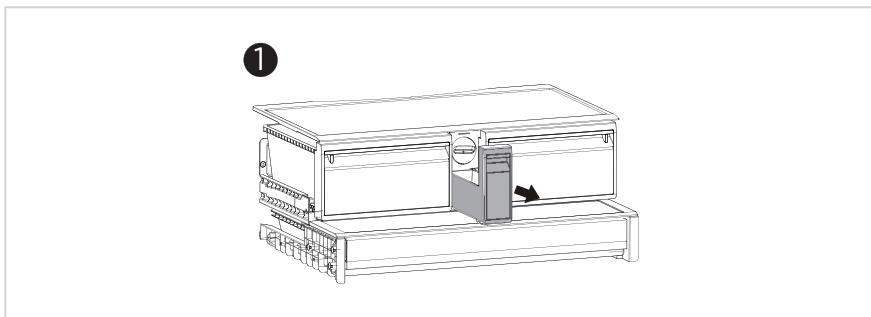

- Pull out the small drawer in the middle.

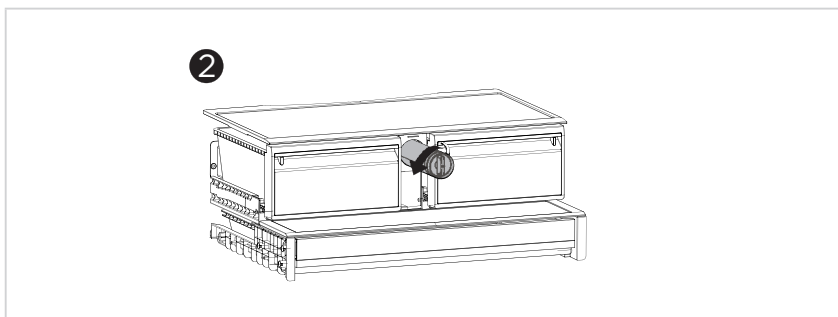

- Press the filter knob and rotate 90° counterclockwise, the filter will disengage from the connector and the filter can be removed.

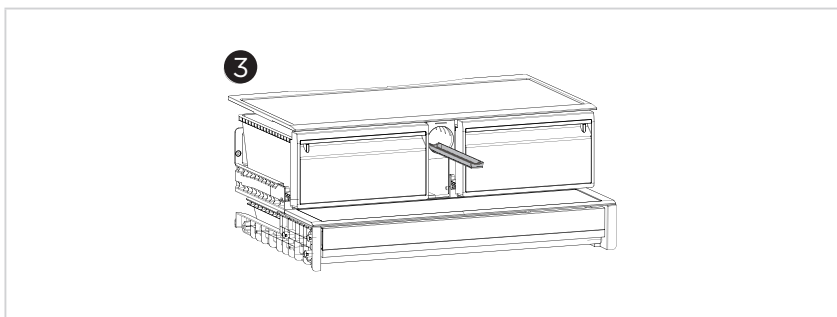

- Check the water tray under the strainer with your finger, take out and dump the overflow water.



Leveling feet

To avoid vibration, the unit must be leveled.

If required, adjust the leveling screws to compensate for the uneven floor.

The front should be slightly higher than the rear to aid in door closing.

Leveling screws can be turned easily by tipping the cabinet slightly.

Turn the leveling screws counterclockwise  to raise the unit, clockwise  to lower it.

Leveling doors

List of tools to be provided by the user



Pliers

1. Raise the lower door up to the level of the higher door.
2. Insert the supplied fastener-ring by using plier in the gap between the hinge-grommet and the lower hinge. The number of fastener-rings you will need to insert depends on the gap.

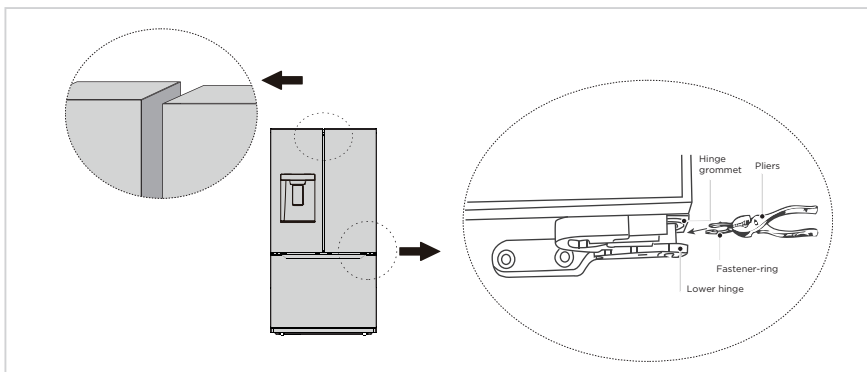

Moving the appliance

1. Remove all food from inside the appliance.
2. Pull the power plug out, insert and fix it into the power plug hook at the rear or on top of the appliance.
3. Tape parts such as shelves and the door handle to prevent from falling off while moving the appliance.
4. Move the appliance with more than two people carefully. When transporting the appliance over a long distance, keep the appliance upright.
5. After installing the appliance, connect the power plug into a socket out to switch on the appliance.

Changing the light

- Any replacement or maintenance of the LED lamps is intended to be made by the manufacturer, its service agent or similar qualified person.

Connecting the appliance

After installing the appliance, connect the power plug into a socket outlet.

ATTENTION

- After connecting the power supply cord (or plug) to the outlet, wait 2 or 3 hours before you put food into the appliance. If you add food before the appliance has cooled completely, your food may spoil.

Precautions before operation:

- Before making changes the refrigerator must be disconnected from power.
- precautions should be taken to prevent any personal injury.

Tips for energy saving

- Do not place the appliance near cookers, radiators or other heat sources. If the ambient temperature is high, the compressor will run more frequently and for longer, resulting in increased energy consumption.
- Ensure that there is sufficient ventilation at the base of the appliance, on the sides of the appliance and at the back of the appliance. Never cover ventilation openings.
- Please also observe the spacing dimensions in the chapter “Installation”.
- The arrangement of drawers, shelves and racks as shown in the illustration offers the most efficient use of energy and should therefore be retained as far as possible. All drawers and shelves should remain in the appliance to keep the temperature stable and save energy.
- To obtain a larger storage space (e.g. for large refrigerated/frozen goods), the middle drawers can be removed. The top and bottom drawers and shelves should be removed last if necessary.
- An evenly filled refrigerator/freezer compartment contributes to optimal energy use. Therefore, avoid empty or half-empty compartments.
- Allow warm food to cool before placing it in the refrigerator/freezer. Food that has already cooled down increases energy efficiency.
- Allow frozen food to defrost in the refrigerator. The coldness of the frozen food reduces the energy consumption in the refrigerator compartment and thus increases the energy efficiency.
- Open the door only as briefly as necessary to minimise cold loss. Opening the door briefly and closing it properly reduces energy consumption.
- The door seals of your appliance must be perfectly intact so that the doors close properly and energy consumption is not increased unnecessarily.

OPERATION INSTRUCTIONS

Control panel

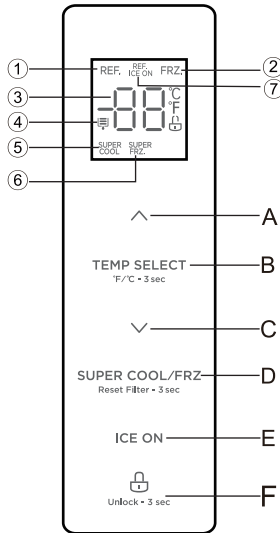

	Display		Button
1	Refrigerating icon	A	Temperature up button
2	Freezer icon	B	Temperature zone selection button
3	Temperature display icon	C	Temperature down button
4	Filter replacement reminder icon	D	Super cool/Super freeze button
5	Super cool icon	E	Ice maker button
6	Super freeze icon	F	Lock/Unlock button
7	Refrigerating ice on icon		

Display

- When electrify the refrigerator, the display screen will totally display for 3 seconds, meanwhile the starting up bell rings ,then the display screen enters the normal display of operation.(if power-on for first time, the default set temperature of the refrigerator room and the freezer room is 39 °F / 0 °F).
- It will display the set temperature of both refrigerator and freezer rooms when there is no fault.



ATTENTION

The actual control panel may differ from model to model.

- Under normal circumstances, the display light will go out after 30 seconds in lock state, button operation on display panel would wake up the display screen; if the opening door action wakes up the display screen, the display light would go out immediately when the door is closed; when the “fault code visible” type of fault occurs, the display screen lights up, and will go out after 30 seconds.

Operating instructions

Lock/Unlock

- In the unlock state, press and hold the button  Unlock - 3 sec for 3 seconds to enter the lock state and the buzzer sound rings.
- In the lock state, press and hold the button  Unlock - 3 sec for 3 seconds to enter the unlock state and the buzzer sound rings.
- It will enter the lock state if there is no opening door action or any buttons operation within 30 seconds.
- The alarm sound can be stopped by pressing any one button in lock state, but all other button operations need to be performed in unlock state.

Refrigerator temperature setting

- Click the button TEMP SELECT 1/2°C - 3sec to change the set temperature of refrigerator room, Each time click the \vee or \wedge , the set temperature will drop 1°F or will rise 1°F. The temperature setting will take effect after the display panel is locked.
- Long press the SUPER COOL/FRZ Reset Filter - 3 sec and  Unlock - 3 sec 4s to close or open the cold storage room.

Freezer temperature setting

- Click the button TEMP SELECT 1/2°C - 3sec to change the set temperature of freezer room, Each time click the \vee or \wedge , the set temperature will drop 1°F or will rise 1°F. The temperature setting will take effect after the display panel is locked.

Mode setting

- Press the SUPER COOL/FRZ Reset Filter - 3 sec button to start the super cool function. The refrigerator room is set at 34°F automatically, and the SUPER COOL icon shines. When exit the super cool mode, the set temperature of refrigerator room will go back to the set temperature before super cool mode.
- Press the SUPER COOL/FRZ Reset Filter - 3 sec button to start the super freeze function. The freezer room is set at -7°F automatically, and the SUPER FRZ. icon shines. When exit the super freeze mode, the set temperature of freezer room will go back to the set temperature before super freeze mode.
- Press the switch button ICE ON to set/cancel the function of the ice maker. When the function setting of the ice maker is effective, the indicator light of the ice maker will be on, otherwise it will be off.
- Long press the ICE ON and TEMP SELECT 1/2°C - 3sec 4s to close or open the ice making room.



Filter element time reset

- Hold down  for 3 seconds to perform the “RESET FILTER” function. At this time, the FILTER working data is cleared.





Celsius transformation

- Long press the  3s to achieve Celsius Fahrenheit conversion function.



Sabbath mode

- Press simultaneous the  and  for 3s to enter or exit the Sabbath mode.
- 6s after entering the Sabbath mode lock, the display goes out, the buzzer does not sound, the door opening lamp does not light up, and the distributor only displays the selected function in low brightness.

Anti-condensation heating element on/off mode.

- Press the  and  for 4 seconds, the Fahrenheit icon flashes, and then press the button , and the anti-condensation heating wire shutdown function is successfully set.
- Under the above settings, unlock and enter again, continue to press the  and  for 4s, the Fahrenheit icon no longer flashes, press the button to release the anti-condensation heating element off function.

Open door prompt sound switch

- At the same time, press  and  button 4s, close or open the door prompt tone.

ATTENTION

If the rear door is not closed after power-on, the machine will give an alarm, call three times after exceeding 2 minutes, and then add one alarm every 1 minute.

Fault indication

- When the following tips to appear on the display screen, it indicates a problem with the refrigerator. Although the refrigerator in the following fault case can still provide cool/freeze functions, but the user should contact maintenance personnel, ensure the normal use of refrigerator.

Fault Code	Fault Description
E1	Temperature sensor failure of refrigerator room
E2	Temperature sensor failure of freezer room
E5	Defrost sensor error of freezer room
E6	Communication error
E7	Ambient temperature sensor error
EH	The humidity sensor fails
F4	The sensor at the bottom of refrigerating ice maker fails
F5	Refrigerating ice maker fails to turn over ice
F6	Initialization fault of refrigerating ice maker
CC	The defrosting sensor in ice making chamber fails
C9	The sensor in ice making chamber fails
CA	The communication between main control board and ice making board fails

ATTENTION

The quick-freezing function is designed to maintain the nutritional value of the food in the freezer. It can freeze the food in the shortest time. If a large amount of food is frozen at one time, it is recommended that the user turn on the quick-freezing function and put the food in. At this time, the freezing speed of the freezer compartment is increased, which can quickly freeze the food, effectively lock the nutrition of the food, and facilitate storage.

Fetching water and Ice

- The ice/water dispenser is located on the outside of refrigerating chamber door. It offers a choice of cubed or crushed ice, or cold water. The dispenser only works when the refrigerating chamber door is closed.

1. Fetching cold water

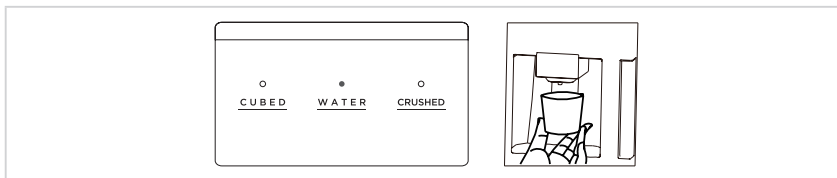

- Keep pressing the buttons WATER until the indicator turns on.
- Push the container in the direction of fetching water cushion, Cold water starts to flow into the container.
- Remove the container from fetching water cushion and end the exporting of water.

2. Fetching crushed ice

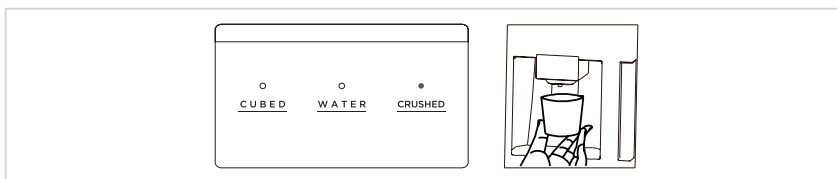

- Keep pressing the buttons of CRUSHED until the signal turns up.
- Make the container tight with mouth of water dispenser to prevent the side jet.
- Press the container in the direction of fetching water cushion. Fill the container with crushed ice.
- Remove the container from fetching water cushion and end the exporting of ice.

3. Fetching ice cubes

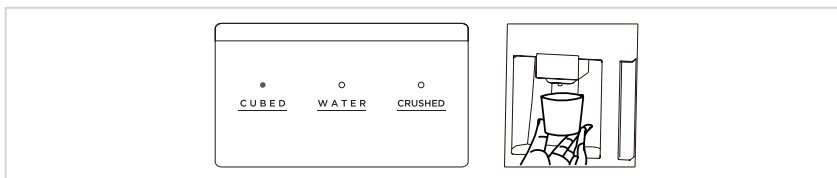

- Keep pressing the buttons CUBED until the signal lights up.
- Push the container in the direction of fetching water cushion, Ice cubes start to fall into the container.
- Remove the container from fetching water cushion and end the exporting of ice.

● ATTENTION

- When the user presses to fetch water/ice, there will be a 2s delay.
- When taking ice, the user should try to keep the container close to the ice outlet to prevent the ice from splashing.

Tips on storing food

Freezer compartment

- The freezer is designated for the storage of food frozen at very low temperature, long-term storage of frozen food, and for the production of ice.
- Only use the shelves in the door of the freezer to store frozen food, not for storing hot food designated for freezing.
- Do not put fresh and frozen food next to each other. The frozen food may thaw.
- When freezing fresh food (such as meat, fish or chopped meat), cut them into parts that can be used at the same time.
- Storing frozen food: instructions are usually stated on the packages, which must be followed. If there is no information on the packaging, food should not be stored for longer than three months from the date of purchase.
- When purchasing frozen food, make sure that it was frozen at a suitable temperature and that the packaging is not damaged.
- Frozen food should be kept in suitable packages to retain the quality and should be returned to the freezer compartment as soon as possible.
- If a package of frozen food shows moisture or abnormal bulging, it is probable that it was stored at the wrong temperature and the content is spoiled.
- The storage period for frozen food depends on the room temperature, the thermostat setting, the frequency of opening the door of the freezer, the type of food and the time of transporting the product from the shop to the household. Always follow the instructions printed on the packaging and never exceed the maximum storage time stated on the package.

Cooling compartment

- To reduce moisture and subsequent ice build-up, never put liquid into the refrigerator in unsealed containers. Frost tends to concentrate in the coolest parts of the evaporator. Storing uncovered liquids results in a more frequent need for defrosting.
- Never put warm foods in the refrigerator. These should first cool down at room temperature and then be placed so as to ensure adequate air circulation in the refrigerator.
- Foods or food containers should not touch the back wall of the refrigerator because they could freeze to the wall. Do not keep regularly opening the door of the refrigerator.
- Meat and clean fish (packed in a package or plastic foil) can be placed in the refrigerator, which can be used in 1-2 days.
- Fruit and vegetables without packaging can be placed in the part designated for fresh fruit and vegetables.

Recommended Temperature

The optimal temperature setting for food storage:

- Fridge: 4 °C(39 °F) , Freezer: -18 °C(0 °F)

ATTENTION

The optimal temperature setting of each compartment depends on the ambient temperature. Above optimal temperature is based on the ambient temperature of 25 °C.

CLEANING AND MAINTENANCE

Defrosting

- The refrigerator is made based on the air-cooling principle and thus has automatic defrosting function. Frost formed due to change of season or temperature may also be manually removed by disconnection of the appliance from power supply or by wiping with a dry towel.

Cleaning of door tray

- According to the direction arrow in the figure below, use both hands to squeeze the tray, and push it upward, then you can take it out.
- After washing the tray having been taken out, you can adjust its installing height in accordance with your requirement.

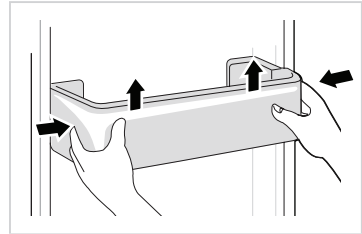

Cleaning of glass shelf

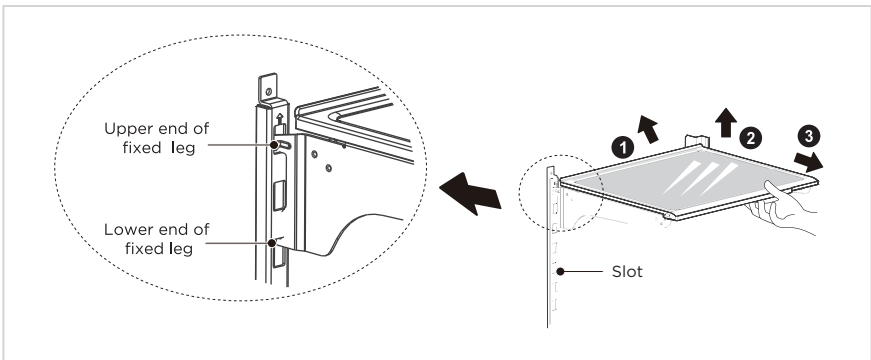

Please dismantle the cantilever shelf according to the arrows shown as above:

1. Please hold the front edge of shelf, and tilt the shelf inwards until the lower end of fixed leg is separated from the slot of supporting iron;
2. Uplift the whole shelf until it can not rise anymore;
3. Take out the shelf horizontally.

During installation, put the upper end of the fixed leg into one of the upper slots on the supporting iron first and then put the lower end of the fixed leg into the third slot on the lower part of the supporting iron.

Cleaning of ice storage box

- When you need to use a lot of ice, or take ice abnormally, or need to clean the ice storage box, you can take out the ice storage box, but please put it back in time.

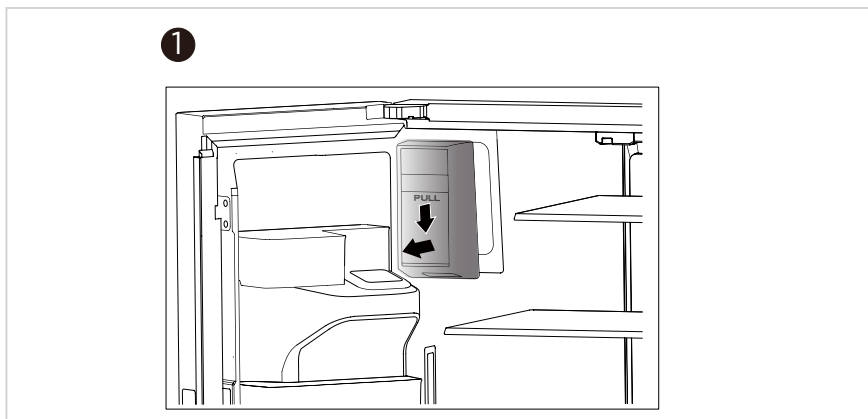

- Hold the button of the ice storage box with your hand, press it gently, and then pull it out horizontally.

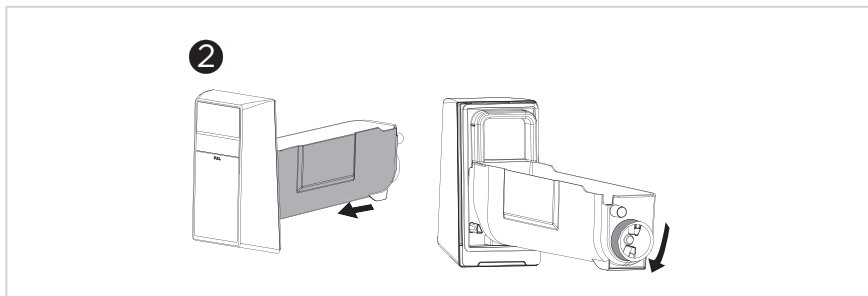

- Push the ice storage box in slightly after cleaning

● ATTENTION

- In the process of pulling out, if ice cubes fall into the ice making room, please clean it up in time.
- If the ice cubes are not used for a long time, please clean them up in time.
- When you need to use a lot of ice cubes, take abnormal ice or need to clean the ice storage box, you can take out the ice storage box and put it back in time.
- When the ice storage box cannot be installed in place, rotate the tail as illustrated to align it with the corresponding position in the ice tank.

Cleaning of freezer drawer

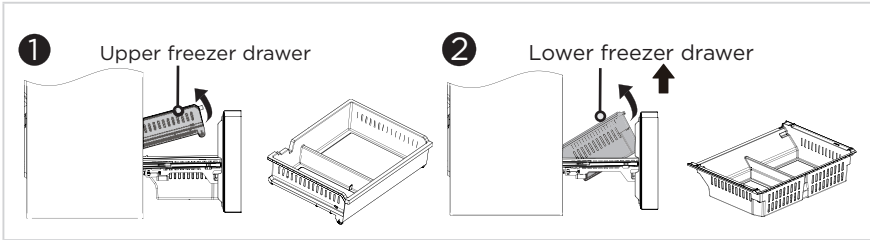

Upper freezer drawer:

- Open the freezing chamber door to the maximum stroke, lift the tail of the upper drawer of the freezing chamber, take out the upper freezer drawer.

Lower freezer drawer:

- Open the freezing chamber door to the maximum stroke, Lift the end of the lower freezer drawer and lift it up.

● ATTENTION

Note: Don't remove the lower freezer drawer if not necessary.

Stop using

Power failure:

In case of power failure, even if it is in summer, foods inside the appliance can be kept for several hours; during the power failure, the times of door opening shall be reduced, and no more fresh food shall be put into the appliance.

Long-time nonuse:

The appliance shall be unplugged and then cleaned; then the doors are left open to prevent odor.

Moving:

Before the refrigerator is moved, take all objects inside out, fix the glass partitions, vegetable holder, freezing chamber drawers and etc. with tape, and tighten the leveling feet; close the doors and seal them with tape. During moving, the appliance shall not be laid upside down or horizontally, or be vibrated; the inclination during movement shall be no more than 45°.

● ATTENTION

The appliance shall run continuously once it is started. Generally, the operation of the appliance shall not be interrupted; otherwise the service life may be impaired.

Foods can be preserved for a couple of hours even in summer in case of power failure; it is recommended to reduce the frequency of opening door.

TROUBLESHOOTING

The following simple issues can be handled by the user. Please call the after-sale service department if the issues are not solved.

Problem	Possible reason
Failed operation	<ul style="list-style-type: none"> • Check whether the appliance is connected to power or whether the plug is in well contact
	<ul style="list-style-type: none"> • Check whether the voltage is too low
	<ul style="list-style-type: none"> • Check whether there is a power failure or partial circuits have tripped
Odor	<ul style="list-style-type: none"> • Odorous foods shall be tightly wrapped
	<ul style="list-style-type: none"> • Check whether there is any rotten food
	<ul style="list-style-type: none"> • Clean the inside of the refrigerator
Long-time operation of the compressor	<ul style="list-style-type: none"> • Long operation of the refrigerator is normal in summer
	<ul style="list-style-type: none"> • When the ambient temperature is high it is not suggestible having too much food in the appliance at the same time
	<ul style="list-style-type: none"> • Food shall get cool before being put into the appliance
	<ul style="list-style-type: none"> • The doors are opened too frequently
Light fails to get lit	<ul style="list-style-type: none"> • Check whether the refrigerator is connected to power supply and whether the illuminating light is damaged
	<ul style="list-style-type: none"> • Have the light replaced by a specialist
Door can not be properly closed	<ul style="list-style-type: none"> • The door is stuck by food packages too much food is placed
	<ul style="list-style-type: none"> • The refrigerator is tilted.
Loud noises	<ul style="list-style-type: none"> • Check whether the floor is level and whether the refrigerator is placed stably
	<ul style="list-style-type: none"> • Check whether accessories are placed at proper locations

Problem	Possible reason
Door seal fails to be tight	<ul style="list-style-type: none"> • Remove foreign matters on the door seal
	<ul style="list-style-type: none"> • Heat the door seal and then cool it for restoration (or blow it with an electrical drier or use a hot towel for heating)
Water pan overflows	<ul style="list-style-type: none"> • There is too much food in the chamber or food stored contains too much water, resulting in heavy defrosting
	<ul style="list-style-type: none"> • The doors are not closed properly, resulting in frosting due to entry of air and increased water due to defrosting
Hot housing	<ul style="list-style-type: none"> • Heat dissipation of the built-in condenser via the housing, which is normal when housing becomes hot due to high ambient temperature, storage of too much food or shutdown of the compressor is shut down, provide sound ventilation to facilitate heat dissipation
Surface condensation	<ul style="list-style-type: none"> • Condensation on the exterior surface and door seals of the refrigerator is normal when the ambient humidity is too high. Just wipe the condensate with a clean towel.
Abnormal noise	<ul style="list-style-type: none"> • Buzz: The compressor may produce buzzes during operation, and the buzzes are loud particularly upon start or stop. This is normal.
	<ul style="list-style-type: none"> • Creak: Refrigerant flowing inside of the appliance may produce creak, which is normal.

Criterion® Refrigerator Warranty

Your product is protected by this warranty:

Warranty service must be obtained from Midea Consumer Services or an authorized Midea servicer.

Warranty

- One year full warranty from original purchase date, includes compressor, parts and labor only.

Midea, through its authorized servicers will:

- Pay all costs for repairing or replacing parts of this appliance which prove to be defective in materials or workmanship.

Midea is not responsible for:

- Diagnostics, removal, transportation and reinstallation cost required because of service.
- Costs of service calls that are a result of items listed under **NORMAL RESPONSIBILITIES OF THE CONSUMER****

Midea replacement parts shall be used and will be warranted only for the period remaining on the original warranty.

NORMAL RESPONSIBILITIES OF THE CONSUMER**

This warranty applies only to products in ordinary household use, and the consumer is responsible for the items listed below:

1. Proper use of the appliance in accordance with instructions provided with the product.
2. Routine maintenance and cleaning necessary to keep the good working condition.
3. Proper installation by an authorized service professional in accordance with instructions provided with the appliance and in accordance with all local plumbing, electrical and / or gas codes.
4. Proper connection to a grounded power supply of sufficient voltage, replacement of blown fuses, repair of loosened connections or defects in house wiring.
5. Expenses for making the appliance accessible for servicing.
6. Damages to finish after installation.

EXCLUSIONS

This warranty does not cover the following:

1. Failure caused by damage to the unit while in your possession (other than damage caused by defect or malfunction), by its improper installation, or by unreasonable use of the product, including without limitation, failure to provide reasonable and necessary maintenance or to follow the written Installation and Operating Instructions.
2. Products purchased "as-is" or refurbished are not covered by this warranty.
3. Food loss caused by refrigerator or freezer failure.
4. Service calls to repair or replace consumables such as water filters, light bulbs air filters etc., or handles, knobs and other cosmetic parts.
5. Product that has been transferred from its original owner.
6. Interior or exterior rust on the unit.
7. Damages caused by services performed by persons other than authorized Midea servicers; use of parts other than Midea replacement parts; obtained from persons other than such Midea customer service; or external causes such as abuse, misuse, inadequate power supply or acts of God.
8. Service calls resulting from improper installation of your product.
9. Service calls to instruct you on the use of your product.
10. Surcharges including, but not limited to, any after hour, weekend, or holiday service calls, tolls, ferry trip charges, or mileage expense for service calls to remote areas, including the state of Alaska.
11. If the unit is put to commercial, business, rental, or other use or application other than for consumer use, we make no warranties, express or implied, including but not limited to, any implied warranty of merchantability or fitness for particular use or purpose.
12. Product that has been removed outside the USA or Canada.
13. Products without original serial numbers or products that have serial numbers which have been altered or cannot be readily determined.

Note: Some states do not allow the exclusion or limitation of incidental or consequential damages. So this limitation or exclusion may not apply to you.

IF YOU NEED SERVICE

Keep your bill of sale, delivery slip, and other appropriate payment record.

The date on the bill established the warranty period should service be required.

If service is performed, it is your best interest to obtain and keep all receipts.

This written warranty gives you specific legal rights. You may also have other rights that vary from state to state.

Service under this warranty must be obtained by following these steps, in order:

1. Contact Midea Consumer Services or an authorized Midea servicer at 1-866-646-4332
2. If there is a question as to where to obtain service, contact our consumer relations Department.

1-866-646-4332

Su producto está protegido por esta garantía:
Midea o por un representante autorizado de Midea.
Para comunicarse con un Representante de Servicio al Cliente, tenga la bondad de llamar por teléfono
sin cargo alguno a Midea, al número:
Su producto está garantizado por Midea. Cualquier obligación de proporcionar servicio o
reparos establecida en esta garantía deberá ser cumplida por los Servicios al consumidor de

Garantía

1-866-646-4332

Your product is protected by this warranty:
Midea Consumer Services or an authorized Midea service
representative. Call Midea TOLL FREE
to contact a Customer Service Representative.
Your appliance is warranted by Midea. Any obligations for services and parts under this warranty must

Product Warranty

Product Warranty Card
Tarjeta de Garantía de Producto



Criterion®



Postage
Required.
Post Office will
not deliver
without proper
postage.

PLACE
STAMP
HERE

Criterion®



Product Support
Midea America Corp.
759 Bloomfield Ave. # 386
West Caldwell, NJ 07006

Criterion[®]