

User Guide Manual

CFRR261WD**

Criterion[®]

Contents

Be sure to keep for safety	1~2
Installation Guide.....	3
Control Panel.....	4
Temperature Control	5
How to use Interior Parts	6
How to use the Dispenser	7
How to use the Automatic Icemaker	8
Care & Cleaning	9~10
Before You Call for Service... ..	11
Something strange? Don't worry. Here is the answer	12
Installation Preparation.....	13
If the refrigerator can not pass through a door during installation, follow these steps.....	13
Refrigerator Leveling & Door Adjustment (if needed.).....	14
Water Filter	16
How to install Water Line.....	16 ~ 17

Be sure to keep for safety!

Read these safety instructions thoroughly and carefully before using. Please keep this user guide on hand for future reference.

 **WARNING** Indicates the possibility of danger of death or serious injury.

 **WARNING** Indicates the possibility of risk of personal injury or material damage.

Other Signs

 DO NOT remove or disassemble!

 Be sure to unplug from outlet/mains!

 NO. DO NOT...

 Be sure to keep and follow!

Caution

1. If the supply cord becomes damaged, it must be replaced by the manufacturer or its service agent or a similarly qualified person in order to avoid a hazard.
2. This appliance is not intended for use by persons (including children) with reduced physical, sensory or mental capabilities, or lack of experience and knowledge, unless they have been given supervision or instruction concerning use of the appliance by a person responsible for their safety.

WARNING

 **Never let the power cord be crushed by the refrigerator itself or other (heavy) objects.**
Never bend power cord excessively.

- If the cord is damaged or peeled, it can be a cause of fire and electric shock.

 **Do not plug several appliances into the same wall outlet.**

- It can be a cause of overheating and/or fire. Use an exclusive grounding receptacle for the refrigerator.

 **Never hold the power cord or plug with wet hands.**

- There is a risk of electric shock.

 **Never use a damaged power cord or plug, or loose main socket.**

- There is a risk of fire, electric shock or serious injury.

 **Be sure to ground. Check if your wall outlet is grounded (earthed).**

- There is a risk of electric shock hazards.

 **Never unplug by pulling only the power cord wire. Always grip the plug firmly.**

 **Let the cord from the plug outlet be directed downwards.**

- If it is directed up, the cord near the plug is bent and can be damaged, which can cause an electric shock or fire.

 **Do not install the refrigerator on a wet floor or in a place with excessive humidity and moisture.**

- Electric insulation gets weakened, resulting in a risk of electric shock hazards.

 **Never let the power cord touch or pass over heating appliances.**

- Power cord can be damaged, resulting in a risk of electric shock hazards.

 **Check if plug is loose from the wall outlet.**

- Electric insulation gets weakened, resulting in a risk of electric shock hazards.

 **Never pour or spray water into the refrigerator (both interior and exterior).**

- Electric insulation gets weakened, resulting in a risk of electric shock hazards.

 **Do not place containers with water or liquid on top of refrigerator.**

- Water can spill into the refrigerator and can cause electric shock hazards or damage.

 **Do not let children hang on the refrigerator doors.**

- Refrigerator can fall and harm them.

 **Do not move or remove compartment shelves/pockets while foods and containers are on them.**

- Hard containers (of glass, metal etc.) can fall to hurt you and can break glass shelf and interior parts.

 **Never repair, disassemble or amend the refrigerator on your own.**

- There is a risk of personal injury or damage to the refrigerator. It is recommended that any service be carried out by a qualified person.

 **Never store any flammable gas or liquid in the refrigerator.**

 **Never use flammable gas, benzene, thinners, gasoline, spray etc. near the refrigerator.**

- There is a risk of fire, explosion and personal injury or damage.

 **If a gas leak is found near the refrigerator or in the kitchen, ventilate it immediately without touching the power plug or refrigerator.**

 **Do not store medicine, academic research samples which require strict temperature control in the refrigerator.**

 **Never insert fingers or hands into the bottom of the refrigerator, especially into the bottom back.**

- You can be hurt by sharp metal edges or can receive an electric shock.

 **Do not change fuse or LED lamp on your own. Call the service agent to change them.**

 **When you find the power cord damaged or cut, call the service agent immediately.**

 **When you get rid of your old refrigerator, be sure to remove the door packings first.**

- Children can be entrapped and suffocated in an abandoned refrigerator.

CAUTION

 **Be sure to unplug the refrigerator when it is not going to be used for a long time.**

 **Never touch foods and containers especially of metal with wet hands in the freezer compartment.**

- You can be hurt by chilblains or cold burns.

 **Never eat any decayed or deteriorated food at all.**

- Foods stored too long in the refrigerator can deteriorate and become decayed.

 **Never place bottles and containers of glass in the freezer compartment.**

- Glass containers and bottles can break and hurt you.

 **When moving the refrigerator (horizontally or tilted), more than 2 persons are required to hold it. (One to hold top back handles, the other to hold the bottom holder.) If other parts are held instead, it is very dangerous and likely to slip.**

 **Be sure to turn up the wheel first before moving the refrigerator.**

- The wheels can damage or scratch the floor. If you are moving it for a long distance, never forget to fasten the interior parts tightly with tapes.
- Otherwise, the parts can collide and break each other.

Installation Guide

* Read these safety instructions carefully before use and follow precautions for your safety.



Precautions in installation and power connection

■ To prevent fire, electric shock or leakage

❶ **Never install the refrigerator on a wet, watery floor or where water can gather easily.**

❷ **Check the following before power connection**

- Connect power plug only to a grounded wall socket (an earthed mains).
- Do not plug refrigerator power together with other appliances to the same socket

❸ **Do not use an adapter plug or an extension cord.**

❹ **Do not let the power cord be crushed by other (heavy) objects.**

- ※If you hear a strange noise, strong chemical odour or find smoke etc. from the refrigerator after the power is plugged in, pull out the plug immediately and call the service agent.
- ※Wait about 5 minutes before you plug-in again in order to prevent any damage to the compressor and electrical devices of refrigerator.
- ※Wait 2~3 hours until the inside gets cold enough after the first power plug-in, then store foods inside.
(There can be some smell of plastic parts on initial operation of the refrigerator.
The smell fades away as the refrigerator works and doors are opened and closed.)



Precautions in use

■ To prevent personal injury, fire, electric shock etc. read this user guide carefully before use and keep it a hand for any reference.

Control Panel



1. Ice Maker button

Press to turn Ice Maker On or Off. If you do not intend to use any ice cubes for longer than one week (e.g. because you are going on holiday), shut down the ice maker.

Initial status: Ice Maker On (LED off)

Press Ice Maker button: Ice Maker OFF (LED on)

2. Freezer Temp button

Press to adjust freezer compartment temperature.

3. Refrigerator button

Press to adjust refrigerator compartment temperature.

4. Door Alarm

When either the refrigerator or the freezer door is left open for more than one minute, the Door Alarm button LED will illuminate and an audible alarm will sound to alert you that the door is open. To turn off the alarm, press the DOOR ALARM button.

5. Quick Freezer (🧊*) / Quick Refrigerator (💧*)
Illuminates when quick function is on.

6. Temperature Mode Switch Function (°F ↔ °C)
If you want to convert from °F to °C or vice versa:
Press and hold the Freezer Temp and Refrigerator Temp for 5 seconds until the temperature mode changes.



- Interior lights of the refrigerator turn off when the doors are open for more than 20 minutes.
- In case either the freezer or refrigerator door is left open for more than a minute, door alarm rings for 5 minutes with 1 minute intervals.

Temperature Control



When changing control settings, wait 24 hours before making additional adjustments. The controls are set correctly when milk or juice is as cold as you would like and when ice cream is firm. If the temperature in either compartment is too cold or too warm, change the setting one increment at a time. Wait 24 hours for the change to stabilize before adjusting again.

- The refrigerator temperature control is preset to 37°F and the freezer control is preset to 0°F. These are recommended temperature settings for normal use conditions.



Freezer Compartment

Push the Freezer button and the temperature setting changes in the sequence as shown below:

>>> Sequential Temperature Change <<<



Quick Freezer function :

To activate Quick Freezer, press and hold the Freezer button for 3 seconds. Quick Freezer LED will turn on. Push the button again to cancel.

The Quick Freezer function is useful to help quickly chill the freezer compartment when needed. For example: If a large quantity of warm food is placed inside the freezer, or if loading the freezer with new groceries which may not be as cold as normal freezer temperatures.

Refrigerator Compartment

Push the Refrigerator button and the temperature setting changes in the sequence as shown below:

>>> Sequential Temperature Change <<<



Quick Refrigerator function :

To activate Quick Refrigerator, press and hold the Refrigerator button for 3 seconds. Quick Refrigerator LED will turn on. Push the button again to cancel.

The Quick Refrigerator function is useful to help quickly cool the refrigerator compartment when needed. For example: If a large quantity of warm food is placed inside the refrigerator, or if loading the refrigerator with new groceries which may not be as cold as normal refrigerator temperatures.



Caution

Food in the refrigerator can be frozen if the ambient Cautiotenperature of the refrigerator is below 5°C.

How to use the interior parts

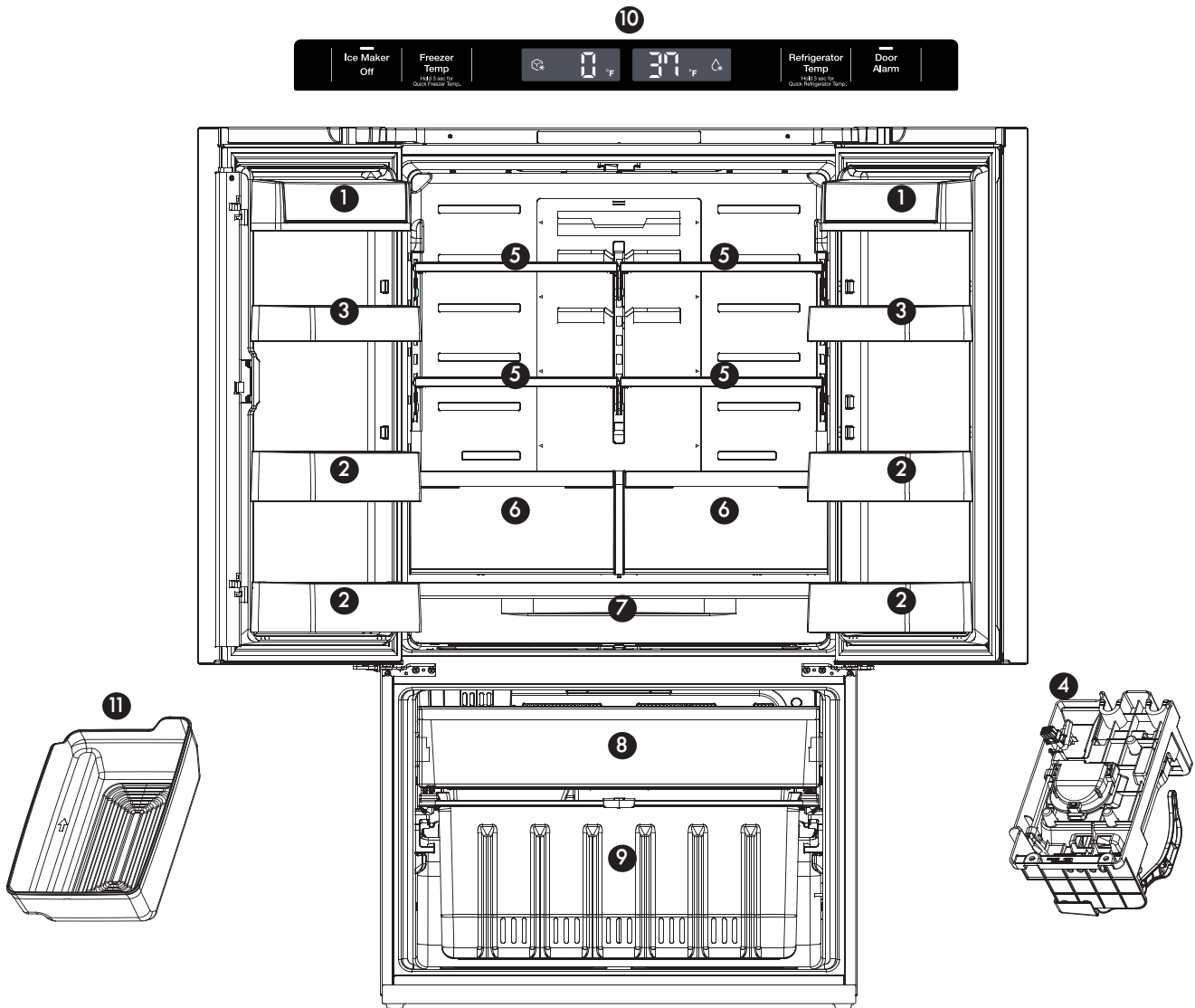

* This instruction manual refers to several models. The real features are model dependent.

- | | | |
|--|--|---|
| <p>1. Covered Dairy Bin or Covered Storage Bin
for storing butter and cheese.</p> <p>2. Gallon door storage bin
for items of medium to large size.</p> <p>3. Low profile door storage bin
for items of medium to large size.</p> <p>4. Ice maker for making ice.</p> | <p>5. Adjustable glass shelf
for items of medium to large size.</p> <p>6. Humidity controlled Crisper Bin
for storage of fruits and vegetables</p> <p>7. Full width pantry drawer
for storage of miscellaneous small items</p> <p>8. Pull out freezer drawer</p> | <p>9. Lower freezer basket
for general freezer storage</p> <p>10. Control and display panel</p> <p>11. Ice storage bin</p> |
|--|--|---|

Caution

- **Do not touch or hold food with wet hands (food container) in the freezer compartment**
☞ There is a risk of chilblains (cold burns).
- Do not store medicine, academic research samples etc. in the refrigerator.

Food Storage Tips

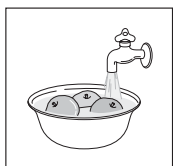

Wash food before storing.

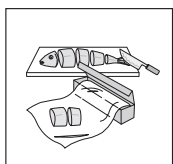

Divide and separate food into smaller pieces.

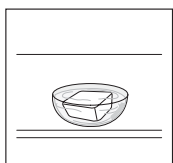

Place watery food or food with a lot of moisture in front shelves (close to door side). If they are placed close to the cold air spout, they can be frozen.



Warm or hot food should be cooled down enough before storing to reduce power consumption and to enhance refrigeration performance.

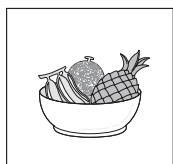

Be careful in storing tropical fruits such as bananas, pineapples and tomatoes, as they can easily deteriorate in lower temperatures.

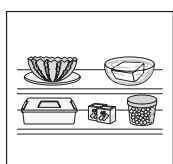

Keep enough space between the foods. If too tight or too close, cold air circulation is hindered, resulting in poor refrigeration.

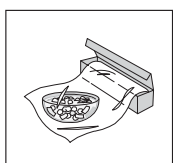

Never forget to cover or wrap food to prevent odours.

Icemaker

In case the icemaker doesn't work

If the ice maker doesn't work, check the following:

- Has it been less than 12 hours since the water supply line installation?
- Is the water line connected and the shut-off valve opened?
- Did you manually stop the ice making function?
- Is the freezer temperature too warm? Try setting the freezer temperature lower.

In case of power failure

In the event of a lengthy power failure, remove ice cubes from the storage bin as the ice may melt.

Shutting down the ice maker

Important!

If you do not intend to use any ice cubes for longer than one week (e.g. because you are going on holiday), shut down the ice maker for that period in order to prevent ice cubes from freezing together.

1. Press the On/Off button for 5 seconds to turn the ice maker off (LED on)
2. Empty and clean the ice cube bin.
3. Return the ice cube bin into position.

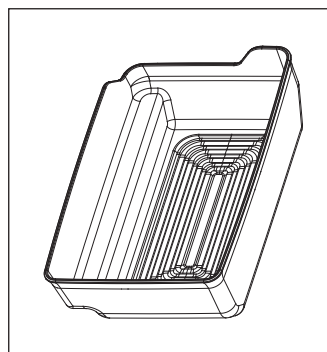

Reactivating the ice maker:

Press the button for 5 seconds to turn the ice maker on (LED off)

Automatic Icemaker



Caution

- The first ice and water dispensed may include particles or odor from the water supply line or the water tank.
- Throw away the first few batches of ice. This is also necessary if the refrigerator has not been used for a long time.
- Never store beverage cans or other items in the ice bin for the purpose of rapid cooling. Doing so may damage the ice maker if the containers burst.
- If discolored ice is dispensed, check the water filter and water supply. If the problem continues, contact a qualified service center. Do not use the ice or water until the problem is corrected.
- To avoid personal injury, keep hands out of the ice maker.

When to set icemaker to off

- When the water supply will be shut off for several hours.
- When the ice bin is removed for more than one or two minutes.
- When the refrigerator will not be used for several days.

NOTE: The ice bin should be emptied when the icemaker ON/OFF button is turned to the OFF mode.

Preparing for vacation

Set the icemaker ON/OFF button to OFF and shut off the water supply to the refrigerator.

NOTE: The ice bin should be emptied any time the icemaker ON/OFF button is turned OFF.

If the ambient temperature will drop below freezing, have a qualified technician drain the water supply system to prevent serious property damage due to flooding caused by ruptured water lines or connections.

How to use the automatic icemaker

The ice maker will produce 10 cubes per cycle -approximately 60 to 100 cubes in a 24-hour period, depending on freezer compartment temperature, room temperature, number of times freezer door is opened, and other use conditions.

Throw away the first few batches of ice to allow the water line to clear.

Be sure nothing interferes with the sweep of the ice maker feeler arm.

When the bin fills to the level of the feeler arm, the ice maker will stop producing ice.

After the ice maker has been turned on again, there will be a time delay before the ice maker resumes operation.

When ice dispenses, it is normal for several cubes to be joined together.

If ice is not dispensed on a regular basis, old ice cubes will discolor and shrink. If you won't be using ice on a regular basis, turn the ice maker off.

Care & Cleaning

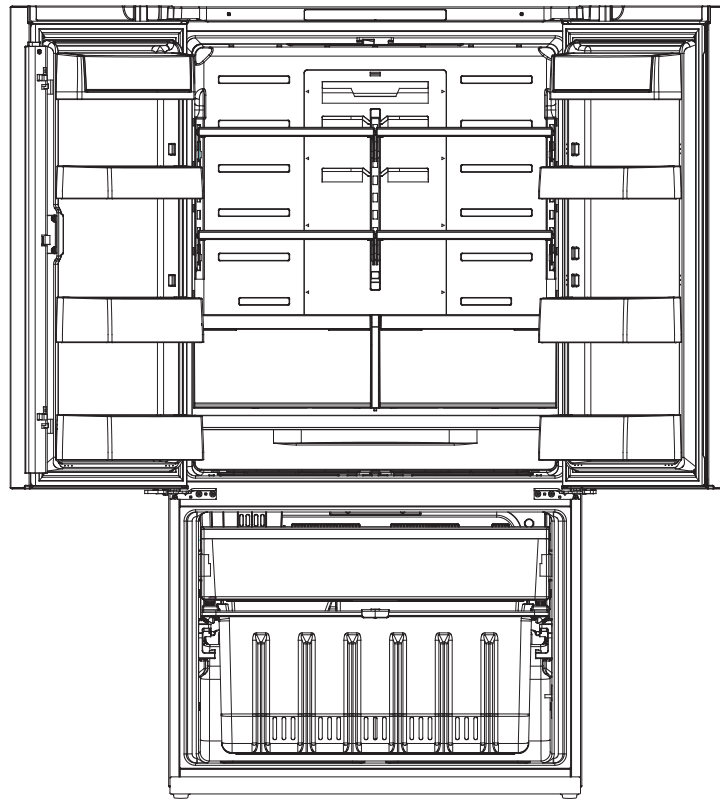

Be sure to unplug first

* Features may vary according to model.

❶ Ice Storage Bin

Cleaning: Empty the ice cube bin and clean with lukewarm water. Thoroughly dry the bin and screw conveyor to prevent new ice cubes from sticking together.

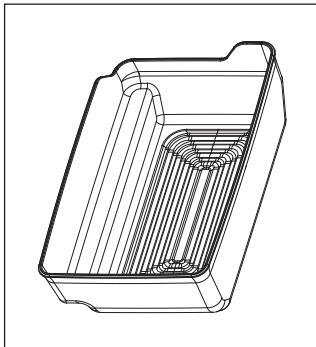

❷ Freezer & Refrigerator Bins

Hold both ends and pull up.

❸ Refrigerator Shelves

To remove a shelf:
Lift up on front of shelf with one hand and with other hand push up on back of shelf to release attachment hooks from attachment slots. Pull the shelf out.

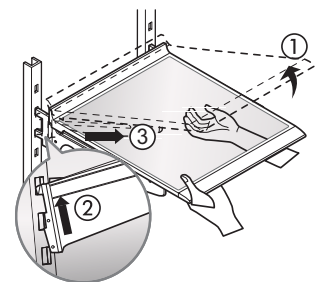

To reinstall a shelf: With front of shelf angled slightly up, engage hooks on back of shelf into attachment slots, and then lower front of shelf into place.

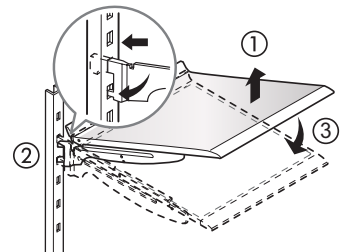

Caution

Make sure that shelves are level from one side to the other. Failure to do so may result in the shelf falling or spilling food.

⑤ Vegetable case & Wide case

- Pull out the cases as far as possible. Lift up the front of the cases and pull them out.
- Insert the cases into the rail and push towards the back.

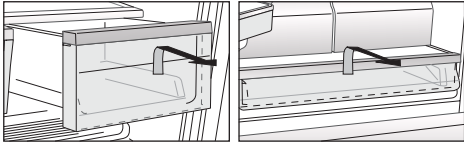

⑥ Freezer case

- Pull out the case as far as possible. Pull out the clips on both sides and lift up the front of the freezer case.

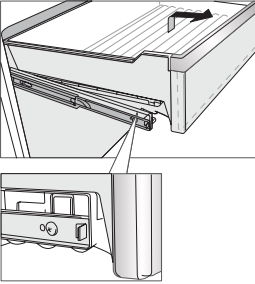

⑦ Freezer drawer

- Lift the freezer drawer up and out.

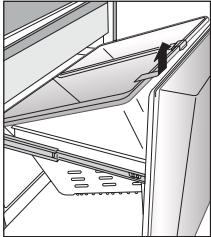

⚡ How to Clean

Interior Parts

- Use cloth with water and mild detergent to clean.



Back (Machine section)

- Remove dust on the grill with a vacuum cleaner at least once a year.

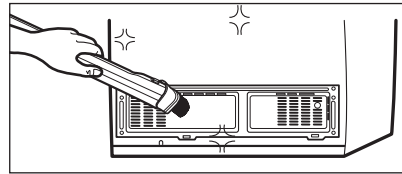

⚡ Caution

Never use petrol, benzene, thinners, scouring pads or harsh abrasives, for they can damage the surfaces.



Before You Call for Service...

Please check the following troubleshooting tips before you call for service!

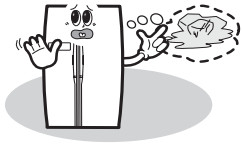

Problem

It never gets cold inside.
Freezing & refrigerating is not so good.

Checkup Point

- 1 Is the refrigerator unplugged?
- 2 Is the temperature set to [Low Mode]?
- 3 Is the refrigerator under direct sunlight or is a heat appliance placed near it?
- 4 Is the space between the refrigerator back and the wall too close?

Action

- 1 Plug in the refrigerator.
- 2 Set the temperature mode to Middle or High.
- 3 Move to a place where there is no direct sunlight, no heat appliances around.
- 4 Keep sufficient space (more than 2 inches) between the back of the refrigerator and the wall.



Problem

Foods in the refrigerator get frozen.

Checkup Point

- 1 Is temperature set to [High]?
- 2 Is the room temperature too low?
- 3 Is food with moisture stored close to the cold air spout?

Action

- 1 Set the temperature to [Middle] or [Low].
- 2 Food can be frozen if ambient temperature is below 5 °C. Move to a place where the temperature is over 5 °C.
- 3 Place food with moisture on the shelves close to the doors.

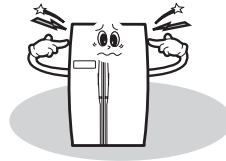

Problem

Strange sounds from the refrigerator.

Checkup Point

- 1 Is the floor beneath the refrigerator uneven?
- 2 Is the space between refrigerator back and the wall too close?
- 3 Do any objects or other stuff touch the refrigerator?

Action

- 1 Move the refrigerator to a level and even floor.
- 2 Keep sufficient space.
- 3 Remove any object which touches the refrigerator.



Problem

Odour or unpleasant smell from the inside.





Checkup Point

- 1 Is the food stored uncovered or unwrapped?
- 2 Are the shelves and pockets stained with food stuff?
- 3 Is the food stored too long?

Action

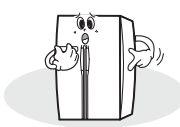
- 1 Be sure to cover and wrap the food.
- 2 Clean them regularly. Once smell gets soaked into those parts, it is not easy to remove.
- 3 Do not store food for too long. A refrigerator is neither a perfect nor a permanent food keeper.

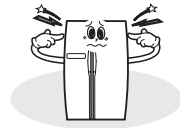
Something strange? Don't worry. Here is the answer.

	Case	Explanation
Heat	Front and side of refrigerator feels warm or hot. 	<ul style="list-style-type: none"> • Pipes (refrigerant vessel) are placed beneath the surface to prevent moisture forming on it.
Door is sticky	Doors do not open easily. 	<ul style="list-style-type: none"> • When you close the door and then open again immediately, the door is not easy to open because warm air rushes in and creates the pressure difference. In this case wait for a minute, then it will open easily.
Strange Sound	It sounds like water is flowing from the refrigerator. 	<ul style="list-style-type: none"> • When the compressor starts to run or stop, refrigerant which makes the inside cold flowing in the pipes can make such a sound. • Defrosted water can also make such a sound. (This refrigerator adopts an automatic defrosting system.)
	Cracking or clicking sounds. 	<ul style="list-style-type: none"> • Inside parts shrink and/or expand due to temperature change --- When the inside gets cold or when the door is open, such sounds can be made.
	Humming or buzzing sounds.	<ul style="list-style-type: none"> • Compressor or fans for cold air circulation can make such working sound. (If the refrigerator is not level, the sound can be louder.)
Frost & Dew	Dew or frost on the wall and/or food container surface in the freezer and refrigerator compartment. 	Frost and/or dew can be made in the following cases; <ul style="list-style-type: none"> • High temperature and/or high humidity around the refrigerator. • When doors are open too long. • Food with much moisture are stored uncovered or unwrapped. ※You can see the same appearance when cold water is poured in a glass cup and dew is forming on the surface of it.
	Dew on the cabinet surface.	<ul style="list-style-type: none"> • If it is highly humid around the refrigerator, moisture in the air sticks to the surface to form dew.

Installation Preparation

Check if the refrigerator can pass a doorway or enter a door first.

Dimensions (including Door Handles)

(Width*Depth*Height) 906 mm x 735 mm x 1,770 mm

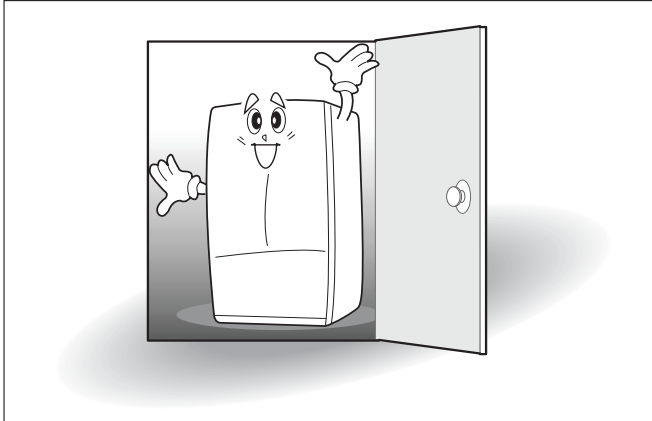

Find a suitable place to install

Sufficient space from the back of the refrigerator to the wall for free air ventilation.

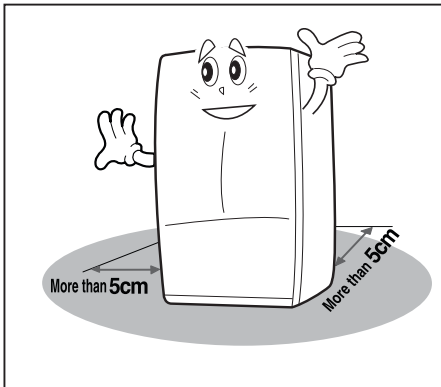

Avoid direct sunlight.

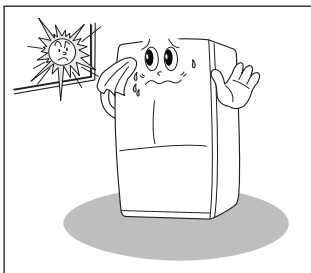

- Once the installation place is ready, follow the installation instructions.
If the surrounding temperature of refrigerator is low (below 5°C), food can be frozen or the refrigerator can function abnormally.

If the refrigerator can not pass through a door during installation, follow these steps.

※This instruction manual refers to several models. The real features are model dependent.

Removing left refrigerator door

- 1 Unscrew top hinge cover with a screw driver and remove the hinge cover.

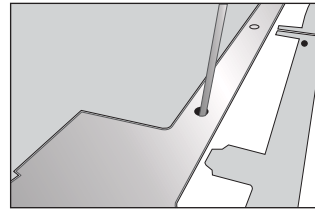

- 2 Unscrew the earth and disconnect the harness wires.

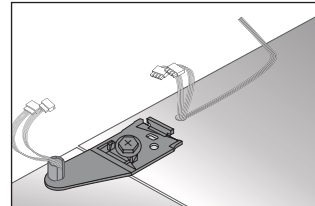

- 3 Turn top hinge fastener counterclockwise and remove the top hinge. (After the hinge is removed, the door can fall down forward. Be careful!)

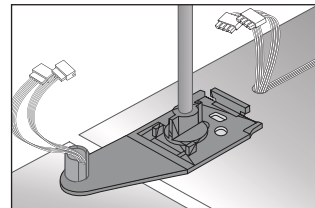

Caution

※ Risk of electric shock! Before removing top hinge cover:

- Shut off the water supply to the appliance.
- sUnplug the appliance or switch off the fuse.

Removing right refrigerator door

1. Turn top hinge fastener counterclockwise and remove the top hinge. (After the hinge is removed the door can fall down forward. Be careful!)
2. Lift up the door and remove it. (The same as step 4, step 5 in removing the left refrigerator door.)

Removing freezer door

- 1 Open freezer door as far as possible, pull up freezer case and freezer drawer.

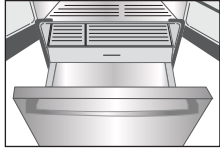

- 2 Push locks (on both sides) and pull the freezer door forward and remove.

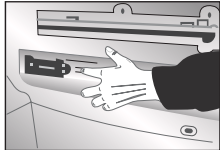

Replacing refrigerator doors

- Replace the left door, right door, then replace the top hinge cover.
- Replacing steps are the reverse of the steps of removing the doors.

Replacing freezer door

- 1 Align the end of rails (both sides) with supporter of freezer drawer rail.

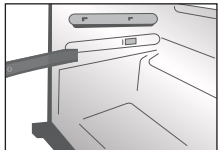

- 2 Fully push and close freezer door, check the locking of the rail with the lock of supporter.

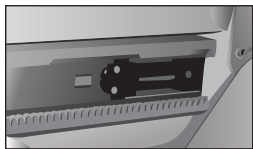

- 3 Open the freezer as far as possible, assemble one gear rail in supporter of rail gear.

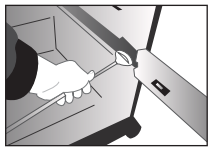

- 4 Push and assemble another gear rail on opposite side of the rail.

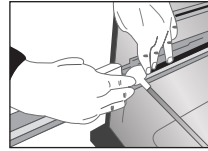

Refrigerator Leveling & Door Adjustment (If needed)

The refrigerator must be level in order to maintain optimal performance and desirable front appearance. (If the floor beneath the refrigerator is uneven, the freezer and refrigerator doors look unbalanced.)

Leveling and door adjustment

Leveling the appliance.

- 1 Pull open the freezer compartment and remove the upper drawer and lower drawer basket to gain access.

- 2 Use a hexagonal wrench to align the front of the appliance.

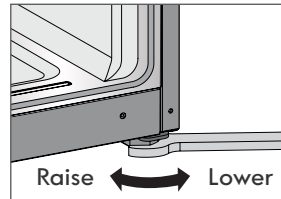

Adjusting a refrigerator door

If the height of the refrigerator doors is uneven, turn the screw nut on the lower hinge to adjust the refrigerator door.

- To raise a refrigerator door turn the screw counterclockwise.

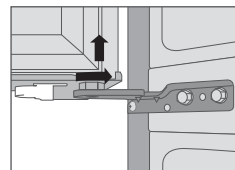

- To lower a refrigerator door turn the screw clockwise.

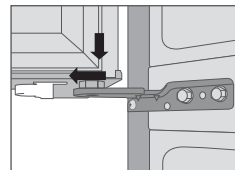

Aligning the refrigerator doors

Caution

⊗ Risk of electric shock! Before removing top hinge cover

1. Shut off the water supply to the appliance.
2. Unplug the appliance or switch off the fuse.

If the refrigerator doors are not properly aligned.

- 1 Unscrew the top hinge cover and raise the panel
Do not disconnect any harness wire.

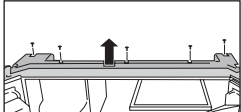

- 2 Loosen the fastener counterclockwise, move the hinge sideways to adjust the refrigerator door.
Do not remove the fastener!

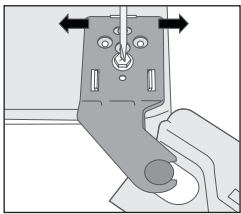

- 3 Tighten the fastener and replace the top hinge cover.

Adjusting the freezer drawer

If the freezer drawer is higher on one side than the other (not even):

1. Loosen the four side screws on the side where adjustment is needed.
2. Move the Stopper from 'left picture position' to 'right picture position'.
3. Adjust the leveling by rotating the Position Knob.
(Pull and rotate the Position Knob)
4. After adjusting the leveling, tighten the four side screws.

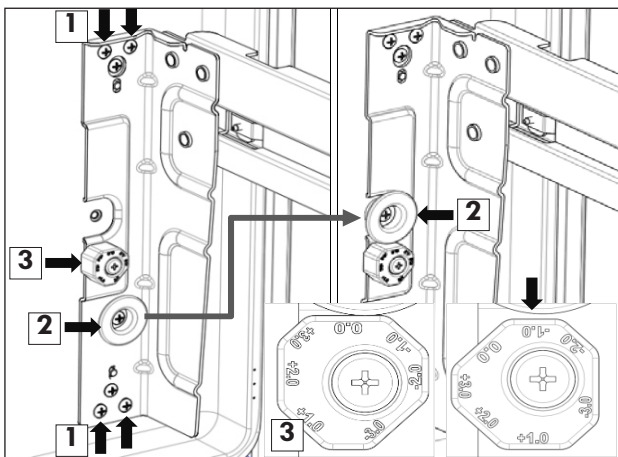

Front Cover

After installation and/or door leveling, fasten front cover with screws. (Remove the screws on the front bottom panel first. Click and screw the cover.)

Caution

- The front of refrigerator needs to be just a little higher than the back for easy door closing, but if the wheel is raised too much for door balance, i.e. the front of refrigerator is much higher than the back, it can be difficult to open the door.

Installing the handles

- After installation and/or door leveling, install the handles.
- All the handles are identical.

- 1 Insert refrigerator door handles into guide.
Fix the handle with screw (supplied).

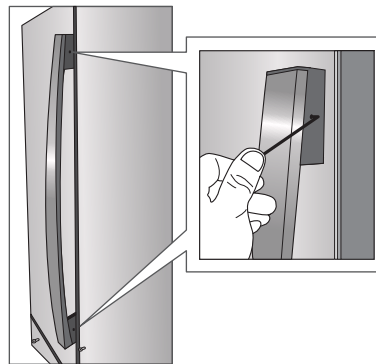

- 2 Insert freezer door handle into guide.
Fix the handle with screw (supplied).

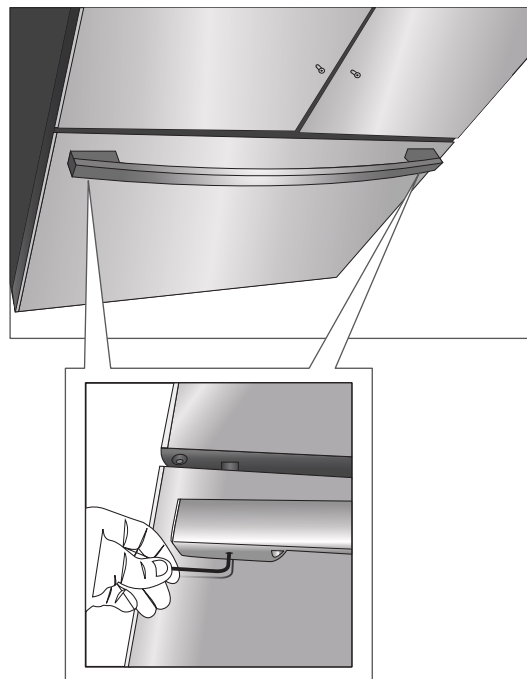

Foldaway door bar (mullion bar)

- When closing the left refrigerator door, the mullion bar folds behind the right refrigerator door, forming a seal between the refrigerator doors.
- When opening the left refrigerator door, the mullion bar folds back to the left door automatically.

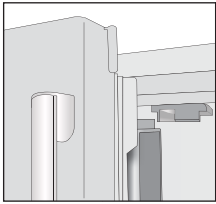

(mullion bar folds back O)

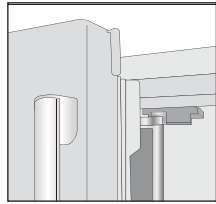

(mullion bar folds away X)

- The mullion bar may become damaged if you attempt to close the left refrigerator door with mullion bar folded out. When closing the left refrigerator door, make sure the mullion bar is folded back.

Water Connector

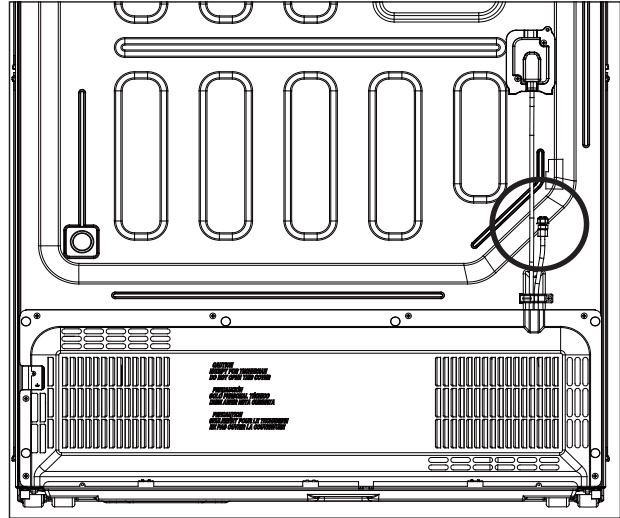

How to install water line

Before you begin

This water line installation is not covered by the refrigerator warranty. Follow these instructions carefully to minimize the risk of expensive water damage. Water hammer (water banging in the pipes) in house plumbing can cause damage to refrigerator parts and can lead to water leakage or flooding. Call a qualified plumber to correct water hammer.



Caution

To prevent burns and product damage, only connect the refrigerator water line to a cold water supply.

If you use your refrigerator before connecting the water line, make sure the icemaker is turned OFF at the control panel.



Caution

Do not install the icemaker tubing in areas where temperatures fall below freezing.

Water pressure

The water pressure must be from 30 to 125 psi or 207-862 kPa or 2.1-8.8 kgf/cm². If the refrigerator is installed in an area with low water pressure “below 30 psi”, you can install a booster pump to compensate for the low pressure.

Limited Warranty

CRITERION

Criterion warrants this refrigerator to be free from defects in material and workmanship and agrees, if unit is found to be defective under normal use and installation, to either repair or replace the unit at the Company's discretion.

Written authorization must be obtained before any merchandise is returned to the factory.

This warranty does not extend to any of our electronic products which have been subjected to misuse, neglect, accident, incorrect wiring not our own, improper installation, unauthorized modification, or to use in violation of instructions furnished by us, nor units which have been repaired or altered outside of our factory, nor to cases where the serial number has been removed, defaced, or changed.

This warranty is in lieu of all warranties expressed or implied and no representative or person is authorized to assume any other liability in connection with the sales of electronic products.

For units that are initially defective.

Initially defective is described as when the dealer opens the unit and finds that it is inoperative or an individual customer opening a new unit and finding that it is initially defective. This unit may be returned to the factory by the dealer for exchange. Under no circumstances will an individual customer be permitted to return defective unit directly to factory. Exchange must be directly with the dealer. When this unit is returned to dealer, a copy of the store receipt stating the date of purchase is to be put in the individual box for dealer's further control with the factory.

<u>MODEL</u>	<u>PARTS</u>	<u>LABOR</u>	<u>COMPRESSOR</u>
Refrigerator	1 year	1 year	1 year

Model: CFRR261WD**

Note: For Service or Assistance, please call : 1-833-946-4227

