



Criterion®
TOP FREEZER

Refrigerator

Use & Care Guide

Table of Contents

Important Safety Instructions	1-2
Installation	3-5
Temperature Controls	6
Looking Inside.....	7-8
Food Storage Tips	9-11
Storing the Refrigerator.....	12
Care & Cleaning	12-13
Troubleshooting.....	14-16
Icemaker Installation	17-22
Warranty & Service	23
Door Removal (If required).....	41
Refrigerators Components	43

T18MACP-01-V1

Important Safety Instructions

E

Installer : Please leave this manual with this appliance.

Consumer : Please read and keep this Use & Care Guide for future reference. This manual provides proper use and maintenance information.

Keep your Bill of Sale, delivery slip, or some other appropriate payment record.

Have complete model and serial number identification of your refrigerator. This is located on a data plate inside the refrigerator compartment, on the upper left side. Record these numbers below for easy access.

Model Number
Serial Number
Date of Purchase

In our continuing effort to improve the quality and performance of our appliances, it may be necessary to make changes to the appliance without revising this guide.

What You Need to Know About Safety Instructions

Warning and Important Safety Instructions appearing in this manual are not meant to cover all possible conditions and situations that may occur. Common sense, caution and care must be exercised when installing, maintaining or operating appliance.

Always contact your dealer, distributor, service agent or manufacturer about problems or conditions you do not understand.

Recognize Safety Symbols, Words, Labels

DANGER – Immediate hazards which WILL result in severe personal injury or death.

WARNING – Hazards or unsafe practices which COULD result in severe personal injury or death.

CAUTION – Hazards or unsafe practices which COULD result in minor personal injury or property damage.



CALIFORNIA PROPOSITION 65

WARNING

The use of this appliance can expose you to chemicals known to the state of California to cause cancer, birth defects, or other reproductive harm. For more information go to www.P65Warnings.ca.gov

To reduce risk of injury or death, follow basic precautions, including the following :

WARNING

When removing the packaging material separate plastic, paper, cardboard and other materials to be sent to recycling companies or collection points. Do not throw them away as domestic garbage.

IMPORTANT : Child entrapment and suffocation are not problems of the past. Junked or abandoned refrigerators are still dangerous – even if they sit out for “just a few days.” If you are getting rid of your old refrigerator, please follow the instructions below to help prevent accidents.

Before you throw away your old refrigerator or freezer :

- Take off the doors.
- Leave the shelves in place so children may not easily climb inside.

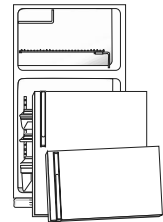

This appliance is equipped with a three-pronged grounding plug for your protection against possible electrical shock hazards. It must be plugged into a grounding receptacle. Where a standard two-prong wall receptacle is encountered, it is the personal responsibility and obligation of the customer to have it replaced with a properly grounded three-prong wall receptacle.

Do not under any circumstances, cut or remove the third (ground) prong from the power cord. Do not use an adapter plug.

Power supply cord with three-prong grounding plug

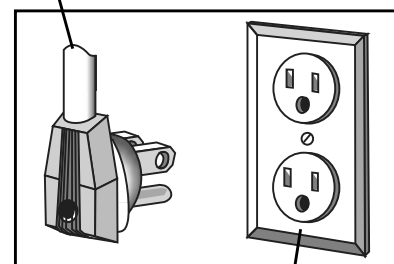

Grounding type wall receptacle

Important Safety Instructions

To reduce risk of fire, electric shock, serious injury or death when using your refrigerator, follow these basic precautions, including the following :

1. Read all instructions before using the refrigerator.
2. Observe all local codes and ordinances.
3. Be sure to follow grounding instructions.
4. Check with a qualified electrician if you are not sure this appliance is properly grounded.
5. Do not ground to a gas line.
6. Do not ground to a cold-water pipe.
7. Refrigerator is designed to operate on a separate 115 volt, 15 amp., 60 cycle line.
8. Do not modify plug on power cord. If plug does not fit electrical outlet, have proper outlet installed by a qualified electrician.
9. Do not use a two-prong adapter, extension cord or power strip.
10. Do not remove warning tag from power cord.
11. Do not tamper with refrigerator controls.
12. Do not service or replace any part of refrigerator unless specifically recommended in Use & Care Guide or published user-repair instructions. Do not attempt service if instructions are not understood or if they are beyond personal skill level.
13. Always disconnect refrigerator from electrical supply before attempting any service. Disconnect power cord by grasping the plug, not the cord.
14. Install refrigerator according to Installation Instructions. All connections for water, electrical power and grounding must comply with local codes and be made by licensed personnel when required.
15. Keep your refrigerator in good condition. Bumping or dropping refrigerator can damage refrigerator or cause refrigerator to malfunction or leak. If damage occurs, have refrigerator checked by qualified service technician.
16. Replace worn power cords and/or loose plugs.
17. Always read and follow manufacturer's storage and ideal environment instructions for items being stored in refrigerator.
18. Your refrigerator should not be operated in the presence of explosive fumes.
19. Children should not climb, hang or stand on any part of the refrigerator.
20. Clean up spills or water leakage associated with water installation.

E

Specifications

MODELS		CTMR183**#*
EXTERNAL DIMENSIONS	WIDTH	29.8 in
	BACKGROUND	31.3 in
	HIGH	67.0 in
NET WEIGHT		168 lbs
SYSTEM CHARACTERISTICS	FREEZER CAPACITY	5.2 cu ft
	FRESH FOOD CAPACITY	13.1 cu ft
	TOTAL CAPACITY	18.3 cu ft
	COOLING SYSTEM	FORCED CONVECTION
	DEFROST SYSTEM	BY RESISTENSE, TYPE SHEATH
	DEFROST SYSTEM	AUTOMATIC
	REFRIGERANT	R 600a
SUPPLY VOLTAGE		115 -V~/60Hz

SAVE THESE INSTRUCTIONS FOR FUTURE REFERENCE

Installation

E

Your new refrigerator was packed carefully for shipment. Remove and discard shelf packing and tape.

Location

- Allow for a free flow of air through the front base grille.
- This refrigerator is intended for use in a location where the temperature ranges from a minimum of 38°F(3.3°C) to a maximum of 110°F(43°C). With temperatures below 38°F (3.3°C) the refrigerator will not run frequently enough to maintain proper temperature in the freezer.
- Allow a minimum ½" clearance on the sides, top and back for ease of installation. If refrigerator is placed with the door hinge side against a wall, you may want to allow additional space so the door can be opened wider.
- Use caution when installing the unit on vinyl or hardwood floors so as not to mark or otherwise damage the flooring. A piece of plywood, a rug or other material should be used to protect the floor while positioning the unit.

Leveling

To enhance its appearance and to maintain performance, your refrigerator should be leveled after it has been rolled into its final location.

- Adjust the leveling/lock screws beneath each front corner at the base of the cabinet.
Turn these leveling / screws clockwise to raise a cabinet corner and counterclockwise to lower a cabinet corner.

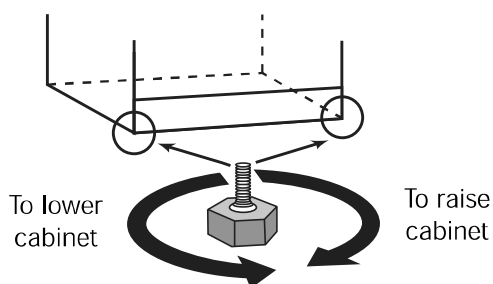

- If the floor is not level and it is necessary to raise the rear of the cabinet, we suggest rolling the rear wheels onto a piece of plywood or other shim material.

Energy Saving Tips

- Locate the refrigerator away from heat producing appliances such as the range or dishwasher, heat vents and direct sunlight.
- Level the refrigerator and do not block ventilation around the front base grille.
- Let hot dishes cool slightly before putting into the refrigerator or freezer.
- Cover liquids.
- Keep the freezer full to near capacity so less cold air will escape during door openings. When the freezer is less than 2/3 full, place milk cartons half full of water in the freezer.
- Wipe moisture from the outside of containers before placing them into the refrigerator.
- Avoid opening the doors too often.

Installation

Reversing Doors

Tools Required :

- 5/16 " end wrench
- Phillips screwdriver
- Putty knife
- 5/16 " socket and ratchet

Unplug the refrigerator.

1. Pry off hinge cap with a putty knife and set aside.
2. With a 5/16 " socket and ratchet, remove screws from the upper hinge and set aside.
3. Carefully lift and remove freezer door (including the upper hinge) off the center hinge.
4. With a 5/16 " socket and ratchet, remove the screws and middle hinge from the top of refrigerator door. With a putty knife, pry out the plug buttons and replace them on the opposite side.
5. Carefully lift and remove refrigerator door.
6. With a 5/16 " socket and ratchet, remove hinge plate from lower corner of refrigerator and secure it on the opposite side.
7. Remove plate from the underside of refrigerator door and secure it on the opposite side with a 5/16 " socket and ratchet.
8. With a 5/16 " socket and ratchet, remove the doorstop from the underside of the freezer door and secure it on the opposite side.
9. With a putty knife, pry out the plug button(s) from tops of freezer and refrigerator doors and replace them on the opposite side.
10. Remove screw hole plugs from top of cabinet and replace on the opposite side.
11. With a 5/16 " socket and ratchet, remove washers and stem from the inside of the hinge plate and place them on the outside of the hinge plate.
12. Carefully replace refrigerator door on the hinge plate in lower corner.
13. Attach the middle hinge with the screws removed from the opposite side and secure them using a 5/16 " wrench.
14. Carefully place freezer door on top of hinge arm. Use foam door spacer to set gap.
15. Slide top hinge into place on freezer door and secure screws with 5/16 " wrench. Confirm that all screws have been tightened securely.
16. Snap hinge cap securely in place.
17. Remember to plug in your refrigerator and reset the controls to the appropriate setting(s).

E

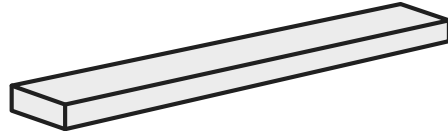

Note

- Do not discard the foam door spacer. Doors may settle with use.

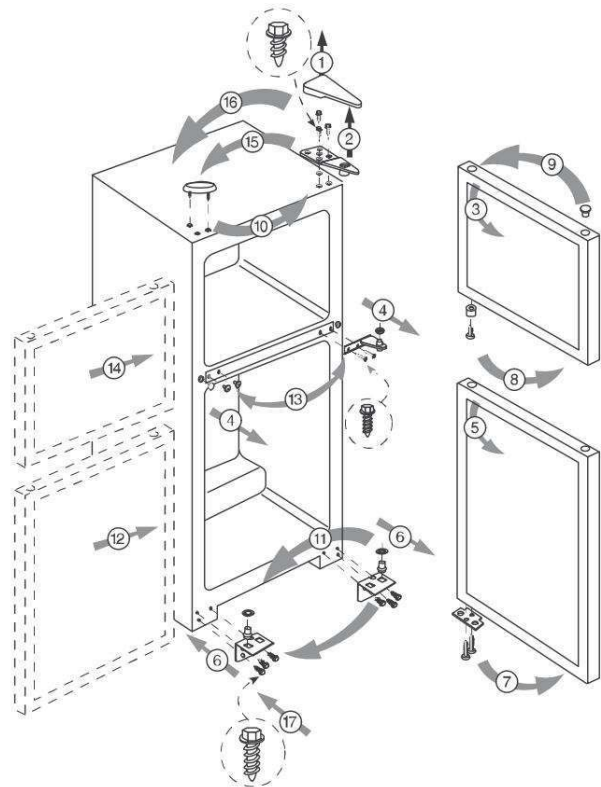

Installation

Note : Phillips screw driver  is required for installation.

E

Freezer Door Handle Installation

1 STEP

Fasten with screw

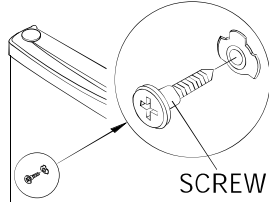

2 STEP

Align handle (A) with mounting screw

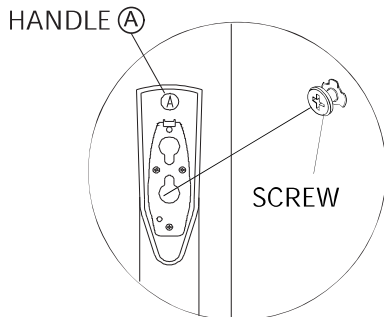

3 STEP

Rotate handle

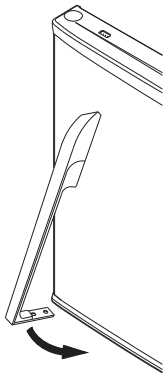

4 STEP

Secure bottom end of handle with two screws.
Do not over-tighten

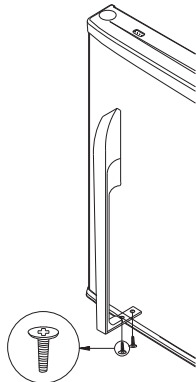

Reversing Door Handles

To remove the handles, reverse the above steps.
Flip the handles 180° and mount them on the opposite doors.

Refrigerator Door Handle Installation

1 STEP

Fasten with screw

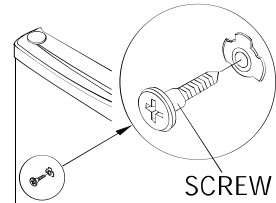

2 STEP

Align handle (B) with mounting screw

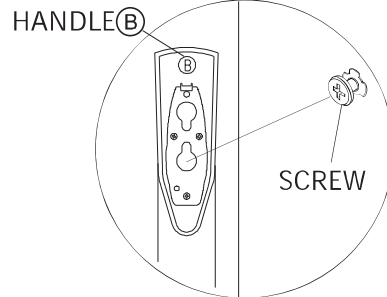

3 STEP

Push handle down

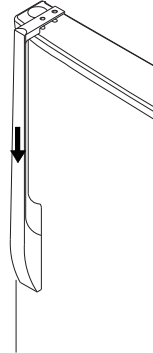

4 STEP

Secure top end of handle with two screws
Do not over-tighten

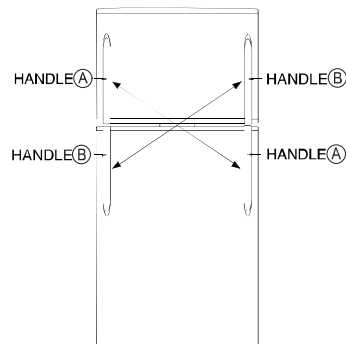
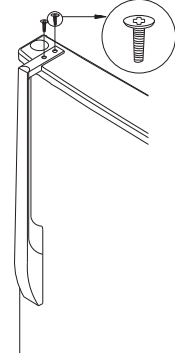

Temperature Controls

E

In some models the fresh food control is located at the top of the fresh food compartment and the freezer control is located at the back of the freezer compartment as shown below.

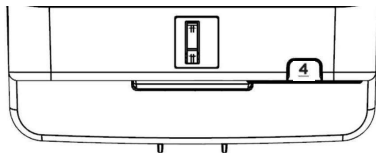

INITIAL SETTING



FREEZER CONTROL

Initial Settings

- The fresh food control has settings from 1 (cold) to 7 (coldest). Initially set this control on 4.
- The freezer control, when located at the back of the freezer, has settings from cold to coldest. Initially set this control at the mid-line initial setting.
- When the freezer control is located at the top of the fresh food compartments, it has settings from 1 (cold) to 7 (coldest). Initially set this control on 4.

Note

- Your refrigerator will run continuously for several hours when you first start it. This is normal.
- Let the refrigerator run at least four hours before adding food.

Adjusting the Temperature Controls

- 24 hours after adding food, you may decide that one or both compartments should be colder or warmer. If so, adjust the control(s) as indicated in the following table.
- Except when starting the refrigerator, do not change either control more than one number at a time.
- Allow 24 hours for temperatures to stabilize before resetting.
- Changing either control will have some effect on the temperature of the other compartment.

TEMPERATURE CONTROL GUIDE	
Fresh Food Compartment too Warm	Adjust fresh food control to next higher setting.
Fresh Food Compartment too Cold	Adjust fresh food control to next lower setting.
Freezer too Warm	Adjust freezer control to next colder setting.
Freezer too Cold	Adjust freezer control to next warmer setting.

* Turning the fresh food control to "OFF" stops cooling in both compartments. It does not shut off power to the refrigerator.

No Defrosting

Your refrigerator is designed to defrost automatically.

Note

- During the automatic defrost cycle, you may notice a red glow/reflection in the vents on the back wall of the freezer compartment and you may hear the sound of water droplets coming into contact with the defrost heater. This is normal during the defrost cycle.

Warm Cabinet Surfaces

At times, the front of the refrigerator cabinet may be warm to the touch. This is a normal occurrence that helps prevent moisture from condensing on the cabinet.

The condition will be more noticeable when you first start the refrigerator, during hot weather and after excessive or lengthy door openings.

Demo Mode (For Store Use Only)

The Demo mode disables all cooling in the refrigerator and freezer sections to conserve energy while on display in a retail store. When Demo Mode is active, the refrigerator light will turn on while all other operations stops.

To activate : turn the dial 2 → 3 → 2

To deactivate : turn the dial 3 → 2 → 3

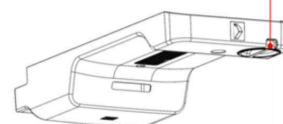
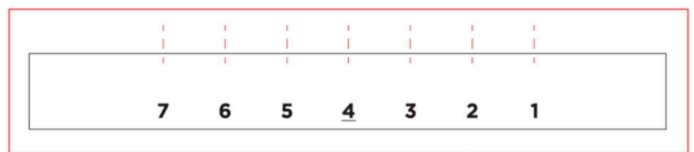

Looking Inside

E

Fresh Food Compartment

Shelves (style may vary)

CAUTION

To avoid personal injury or property damage :

- Never attempt to adjust a shelf when it is loaded with food.
- Confirm that shelf is secure prior to loading items onto it.
- Handle glass shelves with care. Shelves may break suddenly if nicked, scratched or exposed to sudden temperature changes.

Select models are equipped with wire or glass full width shelves that are supported by rails molded into the interior walls of the fresh food compartment.

These shelves can easily be adjusted to alternate positions within the compartment.

The bucket-style **Door Shelves** accommodate a variety of container sizes and shapes.

To Remove :

- Grasp the shelf on each end.
- Lift the shelf up and out.

To Reinstall :

- While holding the shelf on each end, slide the shelf in and down.
- Push down on the interior center of the shelf to snap it completely into place.

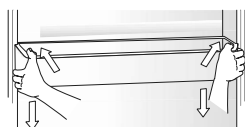

The **Crispers** provide a storage area for fruit and vegetables. Some crisper drawers have sliding humidity controls.



For fruit storage, slide the control (select models) to the left to provide lower humidity conditions in the drawer.

For vegetable storage, slide the control (select models) to the right to provide higher humidity conditions in the drawer.

For best results, keep the crispers tightly closed.

To Remove :

- Pull out the crisper until it stops.
- Tilt the drawer up slightly and pull it out.

To Reinstall :

- With the drawer tilted up slightly, align the drawer in the tracks and slide in. The Crisper Top serves as the lower refrigerator shelf.

To Remove :

- Remove the crisper drawers.
- Slightly lift up the front of the shelf.
- Support the shelf from underneath to lift it up and then out of the cabinet.

To Reinstall :

- With the shelf front tilted slightly upward, carefully insert the crisper top back into the cabinet.
- Position the rear and sides of the shelf on the supports and let the crisper top settle into place.

Looking Inside

E

Dairy Compartment

The **Dairy Compartment** is covered and designed to store spreadable food items such as butter or margarine.

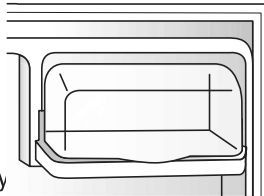

To use this compartment, simply raise the lid to store or retrieve items.

This compartment can be removed for cleaning. Rotate the cover open. Grasp the dairy compartment from the bottom and lift out.

On select models, this compartment can be installed on the left or right side of the door.

Freezer Compartment

CAUTION

- To avoid personal injury or property damage:
- Never attempt to adjust a shelf when it is loaded with food.
 - Confirm that shelf is secure prior to loading items onto it.

Some refrigerators have a full-width shelf in the freezer compartment. This shelf can be adjusted to accommodate a variety of frozen food loads.

Ice Maker (sale separately)

This refrigerator is designed to use an ice machine. Not included in the refrigerator. You can request the sale and installation to the service center by calling the call center.

Different models have different Ice maker that can be installed, so please check whether the ice maker you bought matches your refrigerator.

Kit Ice Maker Model

Ice Maker Model	Refrigerator Model	Code IM Model
EIM-1	CTMR183**#*	60140-0010100-00

Food Storage Tips

E

Fresh Food Storage

- The fresh food compartment of a refrigerator should be kept between 34° F (1° C) and 40° F (4° C) with an optimum temperature of 37° F (3° C). To check the temperature, place an appliance thermometer in a glass of water and place in the center of the refrigerator. Check after 24 hours. If the temperature is above 40° F (4° C) adjust the control as explained on page 6.
- Avoid overcrowding the refrigerator shelves. This reduces the circulation of air around the food and results in uneven cooling.

Fruits and Vegetables

- Storage in the crisper drawers traps humidity to help preserve the fruit and vegetable quality for longer time periods (see page 7).
- Sort fruits and vegetables before storage and use bruised or soft items first. Discard those showing signs of decay.
- Always wrap odorous foods such as onions and cabbage so the odor does not transfer to other foods.
- While vegetables need a certain amount of humidity to remain fresh, too much moisture can shorten storage times (especially leafy items). Drain vegetables well before storing.

Meat and Cheese

- Raw meat and poultry should be wrapped securely so leakage and contamination of other foods or surfaces does not occur.
- Occasionally mold will develop on the surface of hard cheeses (Swiss, Cheddar, Parmesan). Cut off at least an inch around and below the moldy area. Keep your knife or instrument out of the mold itself.

Do not try to save individual cheese slices, soft cheese, cottage cheese, cream, sour cream or yogurt when mold appears.

Dairy Food

- Most dairy foods such as milk, yogurt, sour cream and cottage cheese have freshness dates on their cartons for appropriate length of storage. Store these foods in the original carton and refrigerate immediately after purchasing and after each use.

Frozen Food Storage

- The freezer compartment of a refrigerator should be kept at approximately 0° F (-18° C). To check the temperature, place an appliance thermometer between the frozen packages and check after 24 hours. If the temperature is above 0° F (-18° C), adjust the control as explained on page 6.
- A freezer operates more efficiently when it is at least 2/3 full.

Packaging Foods for Freezing

- To minimize dehydration and quality deterioration use aluminum foil, freezer wrap, freezer bags or airtight containers. Force as much air out of the packages as possible and be sure they are tightly sealed. Trapped air can cause the food to dry out, change color and develop an off-flavor (freezer burn).
- Overwrap fresh meats and poultry with suitable freezer wrap prior to freezing.
- Do not refreeze meat that has completely thawed.

Loading the Freezer

- Avoid adding too much warm food to the freezer at one time. This overloads the freezer, slows the rate of freezing and can raise the temperature of frozen foods.
- Leave a space between the packages so cold air can circulate freely, allowing food to freeze as quickly as possible.
- Avoid storing hard-to-freeze foods such as ice cream and orange juice on the freezer door shelves. These foods are best stored in the freezer interior where the temperature varies less with door openings.

Food Storage Tips

Food Storage Chart

E

Storage times are approximate and may vary depending on type of packaging, storage temperature, and the quality of the food when purchased.

FOODS	REFRIGERATOR	FREEZER	STORAGE TIPS
DAIRY PRODUCTS			
Butter	1 month	6-9 months	Wrap tightly or cover.
Milk and cream	1 week	Not recommended	Check carton date. Close tightly. Don't return unused portions to original container. Don't freeze cream unless whipped.
Cream cheese, cheese spread and cheese food	1-2 weeks	Not recommended	Wrap tightly.
Cottage cheese	3-5 days	Not recommended	Store in original carton. Check carton date.
Sour cream	10 days	Not recommended	
Hard cheese (Swiss, Cheddar and Parmesan)	1-2 months	4-6 months May become crumbly	Wrap tightly. Cut off any mold.
EGGS			
Eggs in the shell	3 weeks	Not recommended	Refrigerate small ends down.
Leftover yolks or whites	2-4 days	9-12 months	For each cup of yolks to be frozen, add 1 tsp. sugar for use in sweet, or 1 tsp. salt for non-sweet dishes.
FRUITS			
Apples	1 month	8 months (cooked)	May also store unripe or hard apples at 60-70° F (16-21° C).
Bananas	2-4 days	6 months (whole/peeled)	Ripen at room temperature before refrigerating. Bananas and avocados darken when refrigerated.
Pears, plums, avocados	3-4 days	Not recommended	
Berries, cherries, apricots	2-3 days	6 months	
Grapes	3-5 days	1 month (whole)	
Citrus fruits	1-2 weeks	Not recommended	May also store at 60-70° F (16-21° C). If refrigerated, store uncovered.
Pineapples, cut	2-3 days	6-12 months	Will not ripen after purchase. Use quickly.
VEGETABLES			
Asparagus	1-2 days	8-10 months	Don't wash before refrigerating. Store in crisper.
Brussels sprouts, broccoli, cauliflower, green peas, lima beans, onions, peppers	3-5 days	8-10 months	Wrap odorous foods. Leave peas in pods.
Cabbage, celery	1-2 weeks	10-12 months	Wrap odorous foods and refrigerate in crisper.
Carrots, parsnips, beets, and turnips	7-10 days	8-10 months	Remove tops. Wrap odorous foods and refrigerate in the crisper.
Lettuce	7-10 days	Not recommended	

Food Storage Tips

E

FOODS	REFRIGERATOR	FREEZER	STORAGE TIPS
POULTRY AND FISH			
Chicken and Turkey, whole	1-2 days	12 months	Keep in original packaging for refrigeration. Place in the Meat and Cheese Drawer. When freezing longer than 2 weeks, overwrap with freezer wrap.
Chicken and Turkey, pieces	1-2 days	9 months	
Fish	1-2 days	2-6 months	
MEATS			
Bacon	7 days	1 month	Fresh meats can be kept in original packaging for refrigeration.
Beef or lamb, ground	1-2 days	3-4 months	
Beef or lamb, roast and steak	3-5 days	6-9 months	Place in the Meat and Cheese Drawer. When freezing longer than 2 weeks, overwrap with freezer wrap.
Ham, fully cooked, whole	7 days	1-2 months	
half	5 days	1-2 months	
slices	3 days	1-2 months	Unopened, vacuum-packed luncheon meat may be kept up to 2 weeks in the Meat and Cheese Drawer
Luncheon meat	3-5 days	1-2 months	
Pork, roast	3-5 days	4-6 months	Processed meats should be tightly wrapped and stored in the Meat and Cheese Drawer
Pork, chops	3-5 days	4 months	
Sausage, ground	1-2 days	1-2 months	
Sausage, smoked	7 days	1-2 months	
Veal	3-5 days	4-6 months	
Frankfurters	7 days	1 month	

Sources : United States Department of Agriculture; Food Marketing Institute; Cooperative Extension Service, Iowa State University

Storing the Refrigerator

Vacations*

If you will be gone for a month or less, leave the controls at the usual settings.

During longer absences :

1. Remove all food.
2. Shut off the ice maker (if installed) and the valve where you tapped into the water line to supply the refrigerator.
3. Disconnect the refrigerator from the electrical outlet.
4. Bleed the water from the ice maker fill line and dry the ice maker thoroughly.

* If using an automatic ice maker, discard first two or three ice harvests, when refrigerator is put back into service.

5. Clean and dry the refrigerator thoroughly.
6. Leave the doors open to prevent odors.

E

WARNING

Water damage due to improper disconnection and drainage may cause mold/mildew growth.

Moving*

When moving, follow instructions listed in Vacations. In addition, remove and carefully pack any items that are easily removable. Ship the refrigerator in an upright position with the doors taped shut.

Care & Cleaning

Refer to the chart on the following page for specific refrigerator cleaning guidelines.

WARNING

To avoid electrical shock which can cause severe personal injury or death :

- Disconnect the power cord before moving or cleaning the refrigerator.
- Disconnect the power cord before replacing the light bulb.

CAUTION

To avoid personal injury :

- Wear gloves when changing a light bulb to protect against possible broken glass.

No Clean Condenser

A clean condenser means more efficient refrigerator operation. Thanks to the unique design of the No Clean Condenser, there is no longer a need for routine condenser cleaning in normal home usage surroundings.

Some operating environments may be particularly dusty or greasy. In these situations, the condenser can be periodically cleaned to insure maximum efficiency.

Cleaning Under the Refrigerator

1. Disconnect the power cord.
2. Raise the locking feet, if engaged (see page 3).

3. To prevent an accidental spill, drain any defrost water which may have accumulated in the defrost drain pan. This pan is located behind the front base grille. To remove the pan, push down on both sides and slide it out.
4. If your model has been connected to a water supply for an automatic ice maker, turn off the water before moving the refrigerator.

5. Pull the refrigerator out from the wall.

Replacing a Light Lamp

**Always use a LED lamp of similar specification
Fresh Food Compartment**

The lamp is located under the top wall of the refrigerator interior

- Remove light shield, if present.
- Unscrew the LED lamp and replace
- Replace the cover in place by hooking the tabs into the corresponding holes

Care & Cleaning

E

WARNING

To avoid electrical shock which can cause severe personal injury or death, disconnect power to refrigerator before cleaning. After cleaning, connect power.

CAUTION

To avoid personal injury or property damage, observe the following :

- Do not touch refrigerated surfaces with wet or damp hands, they may stick to the cold metal surfaces.
- Before cleaning the freezer, allow it to warm up.
- Allow glass shelves to warm up before immersing in warm water.

Care & Cleaning Refrigerator Cleaning Chart

PART		TIPS AND PRECAUTIONS
REFRIGERATOR EXTERIOR		
Front base grille	Mild detergent and warm water. Mild liquid sprays. Vacuum cleaner attachment.	Remove the front base grille (see page 3).
Condenser	Cleaning brush available from your dealer.	No need for cleaning unless environment is particularly greasy, dusty or there is significant pet traffic in the home (see page 12).
Door handles	Mild detergent and warm water. Mild liquid sprays.	
Painted metal surfaces: Cabinet, doors	Mild detergent and warm water. Mild liquid sprays.	Dry with a clean, soft cloth. Do not wipe the refrigerator with a soiled dishwashing cloth or wet towel. These may leave residue that can scratch and weaken the paint. Do not use scouring pads, powdered cleansers, bleach or cleaners containing bleach. These products can scratch and erode the paint finish. Do not wax plastic or vinyl parts.
Defrost Drain Pan	Mild detergent and warm water.	Routine cleaning usually not necessary unless environment is particularly humid or dusty Pan should be drained and cleaned prior to moving the refrigerator (see page 12).
Stainless steel doors (select models)	Light cleaning: mild detergent and warm water Moderate soil: Bon Ami*. Discolorations: Cameo Stainless Steel Cleaner*.	Use a soft cloth or sponge. Always wipe with the grain of the stainless steel. Do not use chlorine bleach or a cleaning product that contains chlorine bleach. After cleaning, rinse and dry. To restore luster and remove streaks follow with Stainless Steel Magic Spray*
Stainless look exterior finish	Wash with a clean, soft cloth or sponge and a mild detergent in warm water.	Do not use abrasive or harsh cleaners, or cleaners designed for Stainless Steel. Dry thoroughly with a soft cloth.
REFRIGERATOR AND FREEZER INTERIOR		
Door gasket	Baking soda and warm water. Mild detergent and warm water.	Use 1-2 table spoons baking soda per quart of water. Be sure to wring out excess water from sponge or cloth when cleaning around controls, lights, or electrical parts.
Glass shelves	Mild detergent and warm water. Glass cleaner. Mild liquid sprays.	Allow the glass to warm up to room temperature before immersing in warm water. Never use hot water.
Interior and door liner	Mild detergent and warm water. Baking soda and warm water.	See above for baking soda solution. Do not use abrasive cleaners, concentrated detergents, bleaches, cleaning waxes, solvents or polish cleaners to clean the refrigerator interior.
Drawers, bins, shelves, etc.	Mild detergent and warm water.	Dry thoroughly. Do not wash in automatic dishwasher

* Brand names are the trademarks of the respective manufacturer

Troubleshooting

Normal Operating Sounds

E

Improvements in refrigeration design may produce sounds in your new refrigerator that are different or were not present in an older model. These improvements were made to create a refrigerator that is better at preserving food, is more energy efficient, and is quieter overall. Because new units run quieter, sounds may be detected that were present in older units, but were masked by higher sound levels. Many of these sounds are normal. Please note that the surfaces adjacent to a refrigerator, such as hard walls, floors and cabinetry may make these sounds seem even louder.

The following are some of the normal sounds that may be noticed in a new refrigerator.

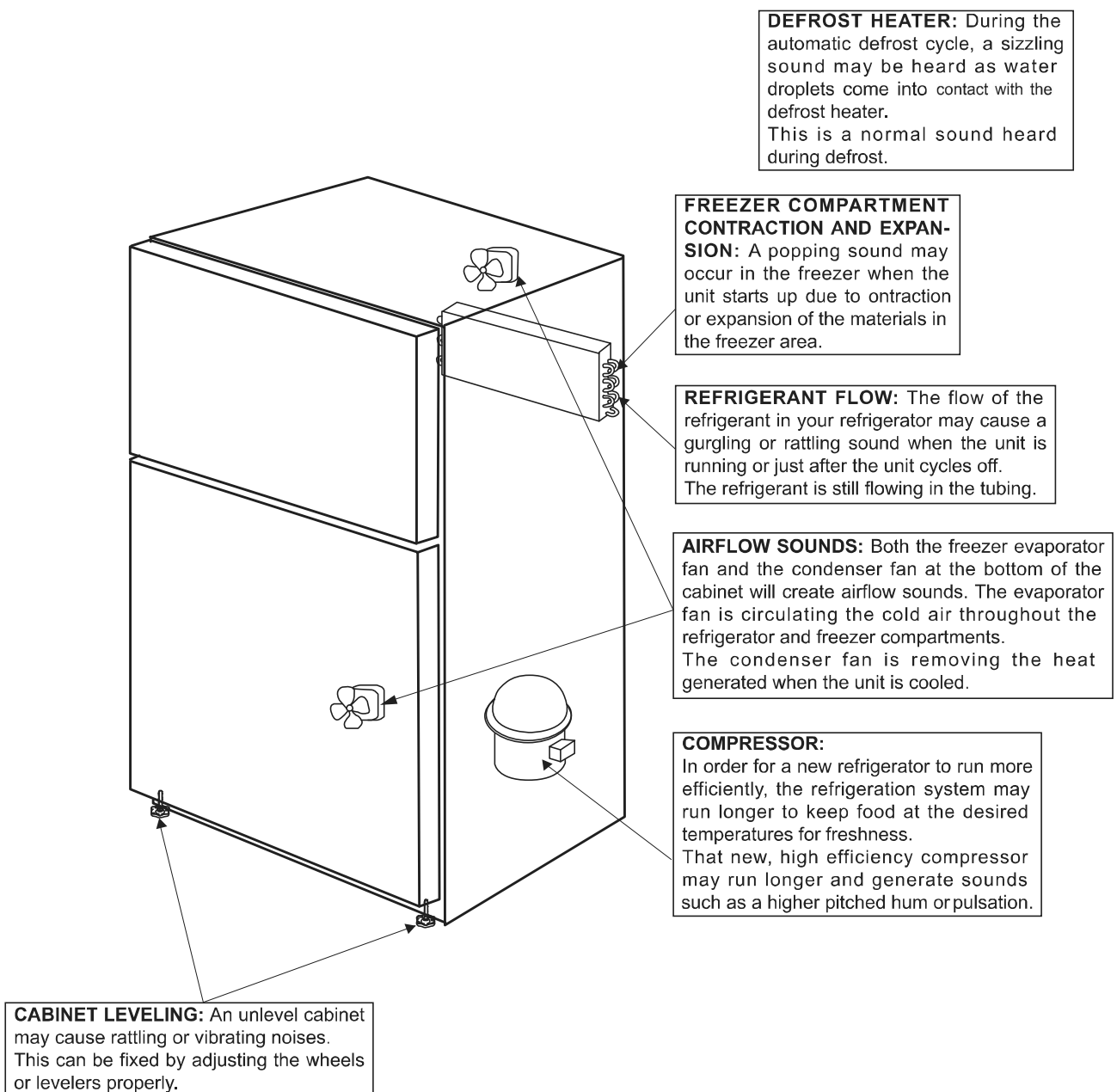

Troubleshooting

E

Review this chart of troubleshooting tips first...you may not need to call for service at all.

	PROBLEM	POSSIBLE CAUSES	WHAT TO DO
GENERAL OPERATION	Won't run	Power cord not plugged in.	Push plug into outlet.
		No power to outlet.	Replace fuse, reset circuit breaker
		Fresh food control set to "OFF" position.	Set fresh food control (see page 6).
		Refrigerator is in automatic defrost.	Wait 25 minutes for defrost cycle to end.
		Room temperature less than 55° F (13° C).	Relocate unit to proper climate (see <i>Installation</i> on page 3).
	Runs too long, too frequently	Today's refrigerators start and stop more often to maintain even temperatures.	
		Normal at startup for new or recently installed units.	Wait 24 hours for refrigerator to completely cool down (see <i>Temperature Controls</i> on page 6).
		Prolonged or frequent door openings.	This is normal. Minimize door openings.
		Door not sealing.	Check to see if something is preventing door from closing
		Front base grille blocked.	Unblock to allow warm air to exit unit.
Light not working	Bulb burned out.	Unplug refrigerator and change bulb (see page 12).	
	No power to unit.	Check to see if power cord is completely plugged in properly	
Visible glow in freezer vents	Appearance of a red glow or reflection is normal during the defrost cycle.		
Warm air from cabinet bottom	This is normal air flow for condenser circulation.		
Cabinet vibrates	Cabinet not level. Weak floor	Level cabinet (see page 3).	
Odor in cabinet	Odor producing foods not covered.	Cover or wrap odorous foods tightly Clean cabinet.	
NOISE	Noise, sounds and vibrations	Normal noise.	See <i>Normal Operating Sounds</i> (page 14).
		Cabinet not level.	Level cabinet (see page 3).
TEMPERATURE	Freezer, refrigerator too warm	Control set too warm. Prolonged door openings.	Adjust temperature control (see page 6). Minimize door openings.
		Room temperature less than 55°F (13° C).	Unit will not run often enough to maintain proper temperatures.
		Products with high sugar content may not harden completely when frozen.	
	Freezer, refrigerator too cold	Control set too cold.	Adjust temperature control (see page 6).

Troubleshooting

E

	PROBLEM	POSSIBLE CAUSES	WHAT TO DO
ICE	Ice cubes have odor/taste	Old cubes.	Discard; ice cubes may absorb odors which affect taste.
		Bad water quality.	Contact local water treatment company.
		Food transmitted odor/taste to ice.	Wrap foods tightly.
	Ice cubes sticking in tray	Residue from minerals in the water.	Wipe trays with vinegar-soaked cloth until clean.
	Ice cubes evaporating	Limited use of ice.	Dump old ice cubes.
MOISTURE	Moisture on cabinet surface between doors	Not unusual during periods of high humidity.	
	Moisture on inside cabinet walls or in crisper	Hot humid weather.	Normal.
		Frequent or prolonged door openings.	Minimize door openings.
		Door not closed properly.	Check to see if something is preventing door from closing.
		Food not wrapped properly.	Wrap or cover all foods tightly.
	Foods dry out	Crisper not tightly closed.	Close crisper all the way.
		Temperature controls set too cold.	Adjust temperature controls (see page 6).
		Packages not wrapped or sealed properly.	Wrap or cover all foods tightly.
	Excessive moisture in crisper	Hot, humid weather.	Minimize door openings.
		Humidity slide on crisper needs adjustment.	Slide control to Fruit setting to allow more moisture to leave the drawer.
Too much moisture on fresh produce before storing.		Do not wash items prior to storage. Wait to wash fresh items until right before use.	
Foods not stored properly.		Store leafy vegetables in a loosely closed plastic bag. Store items with an outer skin (i.e. apples, oranges, pears, grapes, cucumbers, etc.) in a vented bag or unwrapped in the drawer. Store mushrooms and berries in original vented cartons or boxes, not in plastic bags.	

Icemaker Installation

E

Before you begin

Read each step thoroughly before proceeding.

CAUTION – Unplug the Refrigerator. To eliminate the danger of electric shock during installation, you must unplug the refrigerator from its electrical outlet.



Tools you will need



Flat blade and Phillips screwdrivers



Pliers

Parts Included

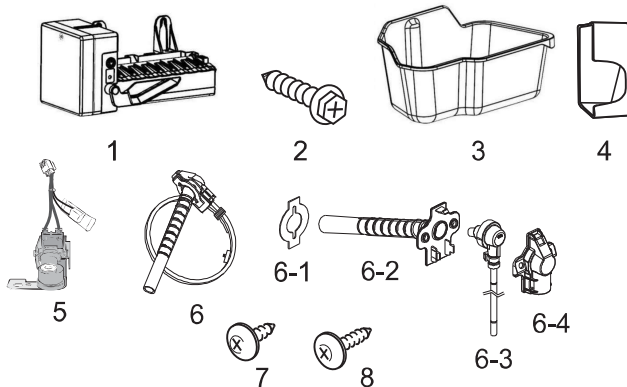

No.	Part Name	Q'ty/Unit
1	CASE ICE MAKER	1
2	SPECIAL C/T BOLT	2
3	BOX ICE	1
4	GUIDE I/WATER	1
5	VALVE WATER AS	1
6	GUIDE CAB W/TUBE A1 AS	1
6-1	SEAL W/TUBE A1	1
6-2	GUIDE CAB W/TUBE A1	1
6-3	GUIDE CAB W/TUBE A2 AS	1
6-4	COVER GUIDE CAB W/TUBE	1
7	SCREW TAPPING	2
8	SCREW TAPPING	2

Remove the outlet cover

Go to the back of the refrigerator. Find the small label in the upper right corner and remove it off. Then discard the label.

Remove the white connector from the upper left corner of the bottom of the freezer.

Remove and discard the white plug from the lower left back corner of the freezer wall.

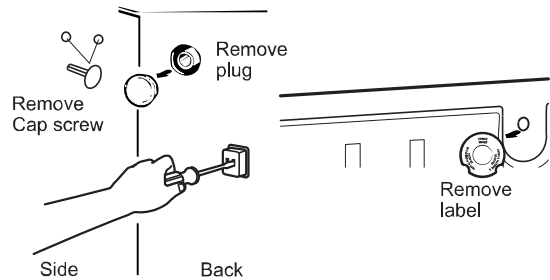

Remove the cover

Use a Phillips head screwdriver to remove the compressor compartment access cover. This requires removing six screws which attach the cover to the back of the refrigerator case.

Be sure to save the screws as the access cover must be reinstalled later to ensure your refrigerator will function properly.



Install Guide Cab W/Tube A1

Remove one side of the seal paper for the water fill tube, slide the seal through the tube and adhere it to the back edge of the water tube inlet.

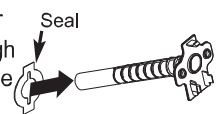

Connect the water line

Make sure there is enough plastic water line to extend from the water valve to well into the water tube inlet. Cut off any excess tubing.

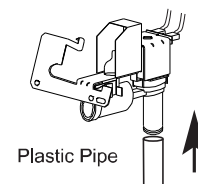

Icemaker Installation

E

Hold the Guide Cab W / Tube A1 and insert the Guide Cab W / Tube A2 connector onto the entrance on the flat part.

Then cover the previous assembly with the Cover Guide Cab W / Tube, ensuring that it fits correctly into the guides on the flat side of the Guide Cab W / Tube A1.

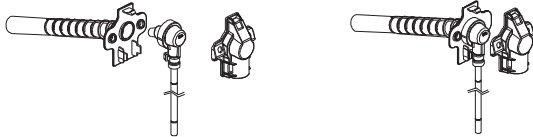

Insert and slide the tube over the center hole at the top, at the back of the refrigerator. Press the same one firmly on the entrance so that it is adjusted to the refrigerator.

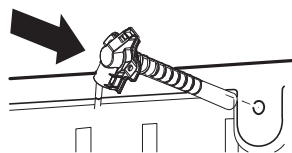

Fix the Water tube to the refrigerator

Press the Guide Cab W / Tube A1 assembly as soon as it is inserted into the back of the refrigerator. Insert the screws into the holes in the Cover Guide Cab using the T1 4x16 mm screws. Keep the fixed pipe by applying cotton tape over the plastic pipe, approximately 1 1/2 (40mm)

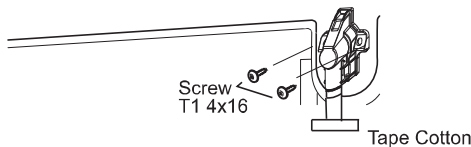

Route and attach the plastic water line

Attach the plastic water pipe to the back of the cabinet with the cotton adhesive tape, separating as shown to tighten the pipe.

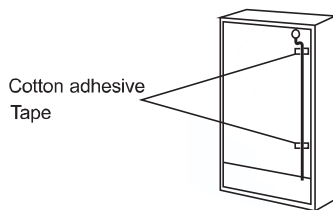

Install the water valve

Locate the male connector plug on the valve. Locate and insert the female connector on the bottom of the refrigerator. Observe the correct way to connect both connectors.

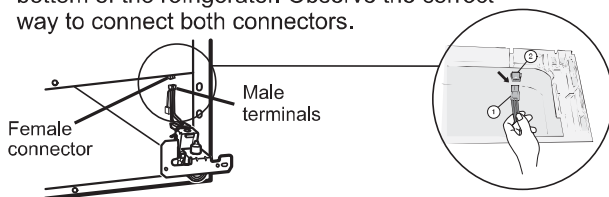

Attach the water valve to the cabinet by inserting the T1 4x14 mm Phillips head screw from the kit into the hole in the base of the cabinet.

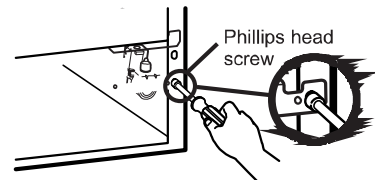

Prepare for Installation

Inside the freezer, loosen the two mounting screws, but do not screw them all the way out. If your model does not have the screws already in the freezer wall, look for two plug buttons. Remove the plug buttons and insert the two phillips head screws. The screws should extend approximately 1/2" (13mm) out from the freezer wall.

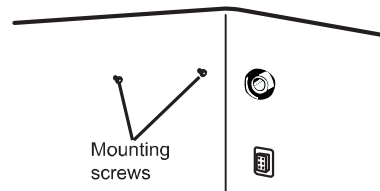

Install the Icemaker Fill Cup

Install the icemaker fill cup (side-mounted) into the icemaker as shown.

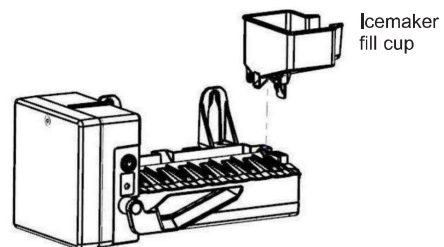

Icemaker Installation

E

Plug in the Icemaker

Holding the icemaker in place, insert the icemaker power cord plug into the socket on the back wall, making sure the prongs and holes are matched. Press the plug firmly into the socket. Lock the plug in place by clipping the restraints onto each side of the plug. Make sure the restraints click into place.

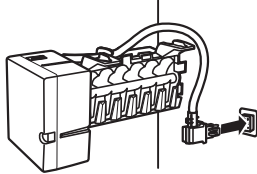

Mount the Icemaker

Lift the icemaker so the fill tube extension fits in the fill cup opening. Hang the icemaker on the two screws.

Make sure:

The power cord is still firmly in the socket.

The fill tube extension extends into the fill cup opening at the back of the icemaker. (Check the rear of the refrigerator to make sure the fill tube has not been pushed out of the back of the refrigerator).

The icemaker mounting screws are located in the uppermost position of the mounting slots.

Then securely tighten the icemaker mounting screws.

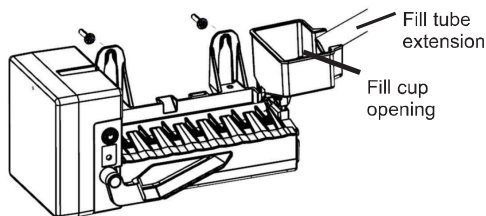

Install the Ice Bucket

Place the ice bucket under the icemaker.



Water Valve Installed

After water line installation is completed, set the icemaker power switch to I (on).

The icemaking cycle will not begin until the icemaker and freezer compartment reach operating temperature.

Installing the water line

BEFORE YOU BEGIN

This water line installation is not warranted by the refrigerator or icemaker manufacturer. Follow these instructions carefully to minimize the risk of expensive water damage.

Water hammer (water banging in the pipes) in house plumbing can cause damage to refrigerator parts and lead to water leakage or flooding. Call a qualified plumber to correct water hammer before installing the water supply line to the refrigerator.

To prevent burns and product damage, do not hook up the water line to the hot water line.

If you use your refrigerator before connecting the water line, make sure the icemaker power switch is in the O (off) position (on power switch models) or the feeler arm is in the STOP (up) position (on feeler arm models).

Do not install the icemaker tubing in areas where temperatures fall below freezing.

When using any electrical device (such as a power drill) during installation, be sure the device is double insulated or grounded in a manner to prevent the hazard of electric shock, or is battery powered.

All installations must be in accordance with local plumbing code requirements.

WHAT YOU WILL NEED

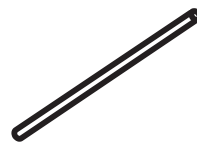

- Refrigerator copper tubing 1/4" outer diameter to connect the refrigerator to the water supply. If using copper, be sure both ends of the tubing are cut square.

To determine how much tubing you need: Measure the distance from the water valve on the back of the refrigerator to the water supply pipe. Then add 8' (2.4 m). Be sure there is sufficient extra tubing to allow the refrigerator to move out from the wall after installation.

- A cold water supply. The water pressure must be between 20 and 120 p.s.i. (1.4–8.1 bar).

Icemaker Installation

- Power drill.
- 1/2 " or adjustable wrench.
- Straight and Phillips blade screwdriver.

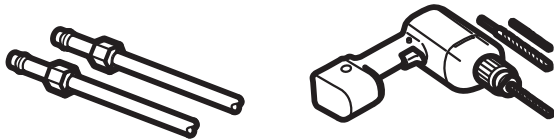

- Two 1/4 " outer diameter compression nuts and 2 ferrules (sleeves)—to connect the copper tubing to the shutoff valve and the refrigerator water valve.
- If your existing copper water line has a flared fitting at the end, you will need an adapter (available at plumbing supply stores) to connect the water line to the refrigerator OR you can cut off the flared fitting with a tube cutter and then use a compression fitting.

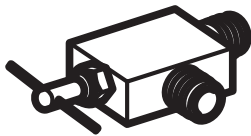

- Shutoff valve to connect to the cold water line. The shutoff valve should have a water inlet with a minimum inside diameter of 5/32 " at the point of connection to the cold water line. Saddle-type shutoff valves are included in many water supply kits. Before purchasing, make sure a saddle-type valve complies with your local plumbing codes.

Install the shutoff valve on the nearest frequently used drinking water line.

Shut off the main water supply

Turn on the nearest faucet long enough to clear the line of water.

Choose the valve location

Choose a location for the valve that is easily accessible. It is best to connect into the side of a vertical water pipe. When it is necessary to connect into a horizontal water pipe, make the connection to the top or side, rather than at the bottom, to avoid drawing off any sediment from the water pipe.

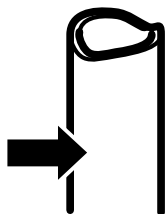

Drill the hole for the valve

Drill a 1/4 " hole in the water pipe (even if using a self-piercing valve), using a sharp bit. Remove any burrs resulting from drilling the hole in the pipe. Take care not to allow water to drain into the drill. Failure to drill a 1/4 " hole may result in reduced ice production or smaller cubes.

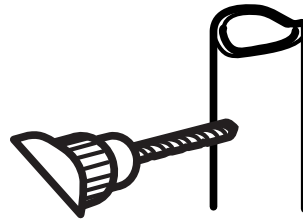

Fasten the shutoff valve

Fasten the shutoff valve to the cold water pipe with the pipe clamp.

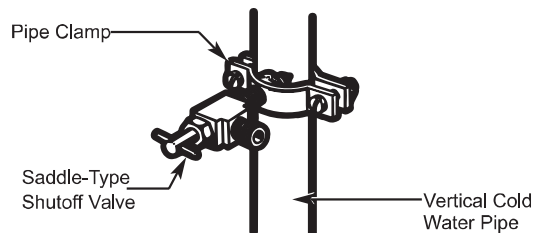

NOTE: Commonwealth of Massachusetts Plumbing Codes 248CMR shall be adhered to. Saddle valves are illegal and use is not permitted in Massachusetts. Consult with your licensed plumber.

Tighten the pipe clamp

Tighten the clamp screws until the sealing washer begins to swell.

NOTE: Do not overtighten or you may crush the tubing.

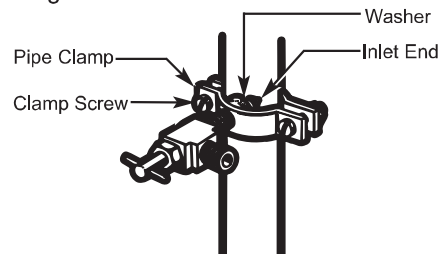

E

Icemaker Installation

E

Route the tubing

Route the tubing between the cold water line and the refrigerator.

Route the tubing through a hole drilled in the wall or floor (behind the refrigerator or adjacent base cabinet) as close to the wall as possible.

NOTE: Be sure there is sufficient extra tubing to allow the refrigerator to move out from the wall after installation.

Connect the tubing to the valve

Place the compression nut and ferrule (sleeve) for copper tubing onto the end of the tubing and connect it to the shutoff valve.

Make sure the tubing is fully inserted into the valve. Tighten the compression nut securely.

For plastic tubing, insert the molded end of the tubing into the shutoff valve and tighten compression nut until it is hand-tight; then tighten one additional turn with a wrench. Overtightening may cause leaks.

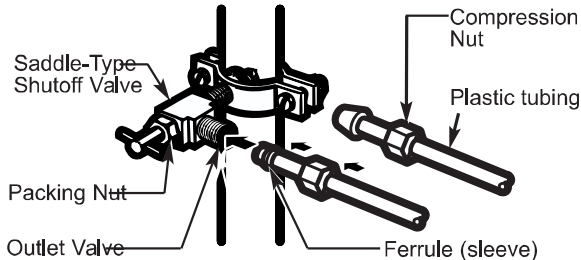

NOTE: Commonwealth of Massachusetts Plumbing Codes 248CMR shall be adhered to. Saddle valves are illegal and use is not permitted in Massachusetts. Consult with your licensed plumber.

Flush out the tubing

Turn the main water supply on and flush out the tubing until the water is clear.

Shut the water off at the water valve after about one quart (1 liter) of water has been flushed through the tubing.

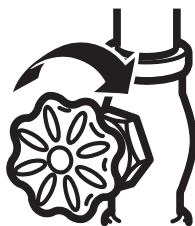

Connect the tubing to the refrigerator

NOTES:

- Before making the connection to the refrigerator, be sure the refrigerator power cord is not plugged into the wall outlet.
- We recommend installing a water filter if your water supply has sand or particles that could clog the screen of the refrigerator's water valve. Install it in the water line near the refrigerator.

Remove the screws holding the right side of the access cover. Fold back the cover.

Remove the plastic flexible cap from the water valve (refrigerator connection).

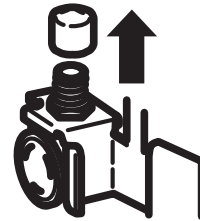

Place the compression nut and ferrule (sleeve) onto the end of the tubing as shown.

Insert the end of the tubing into the water valve connection as far as possible. While holding the tubing, tighten the fitting.

For plastic tubing, insert the molded end of the tubing into the water valve connection and tighten compression nut until it is hand-tight; then tighten one additional turn with a wrench. Overtightening may cause leaks.

Fasten the tubing into the clamp provided to hold it in a vertical position. You may need to pry open the clamp.

One of the illustrations below will look like the connection on your refrigerator.

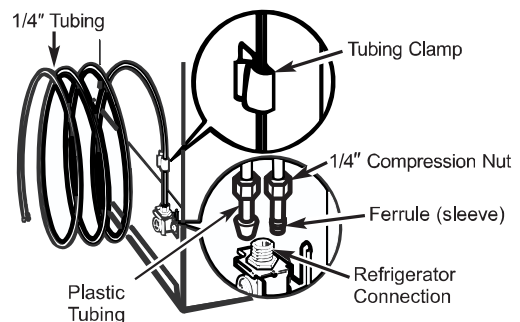

Icemaker Installation

Turn the water on at the shutoff valve

Tighten any connections that leak.

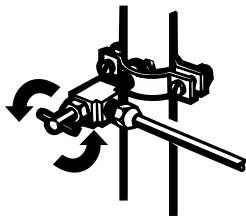

Reattach the access cover.

Plug in the refrigerator

Arrange the coil of tubing so that it does not vibrate against the back of the refrigerator or against the wall. Push the refrigerator back to the wall.

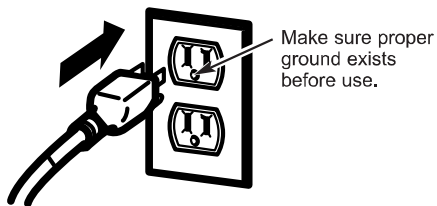

Important: Please read carefully for personal safety, this appliance must be properly grounded

The power cord of this appliance is equipped with a 3-prong (grounding) plug that mates with a standard 3-prong (grounding) wall receptacle to minimize the risk of electric shock hazard from this appliance. The customer should have the wall receptacle and circuit checked by a qualified electrician to make sure the receptacle is properly grounded.

Where a standard two-prong wall receptacle is encountered, it is the personal responsibility and obligation of the customer to have it replaced with a properly grounded 3-prong wall receptacle.

Do not, Under any circumstances, cut or remove the third (ground) prong from the power cord.

Start the Icemaker

E

When plug in the refrigerator, the ice maker starts automatically with the LED lamp turned on. (If the LED Lamp is off, in short press the button once(1sec)) The motor of ice maker rotates to set the motor's origin after 5 minutes, so when the ice maker is installed, turn on the refrigerator. The icemaker will not begin to operate until it reaches its operating temperature of 15°F (-9°C) or below. It will then begin operation automatically.

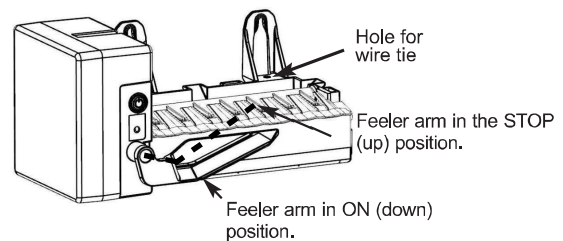

NOTE: In lower water pressure conditions, the water valve may turn on up to 3 times to deliver enough water to the icemaker.

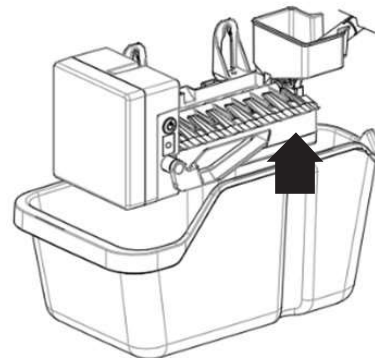

NOTE: Your Icemaker has a automatic shutoff. As ice is made, the ice cubes will fill the ice storage bin and the ice cubes will raise shutoff arm to the OFF (arm up) position.

CRITERION WARRANTY

Guarde este libro para su custodia. Debe proporcionar una prueba de compra o prueba de instalación para el servicio de garantía.

<p>Staple your proof of purchase here.</p> <p>Write down the following information about your appliance for your convenience. You can find the model and serial number label located on the back of your appliance.</p>	Dealer name _____
	Address _____
	Phone number _____
	Model number _____
	Serial number _____
	Purchase date _____

1YEAR WARRANTY ON PARTS AND LABOR. For one year from the date printed on the proof of purchase, when the appliance is installed, operated, and maintained according to instructions attached to or furnished with the appliance, Criterion warrants to replace or repair parts to correct defects in materials or workmanship that existed when the appliance was purchased. In-home service will be provided during the warranty labor period subject to availability within the United States. In-home service is not available in all areas. To receive in-home service, the product must be unobstructed and accessible to service personnel. If during in-home service repair cannot be completed, it may be necessary to remove, repair and/ or return the product. If in-home service is unavailable, Criterion may elect, at our option, to provide for transportation of our choice to and from a Criterion authorized service center. Otherwise, transportation to and from the Criterion authorized service center is the responsibility of the purchaser. Under the diagnosis of a Criterion authorized technician, if the appliance is deemed unrepairable and needs a replacement, your appliance will be warranted for the remaining term of the original unit's warranty period.

THIS WARRANTY DOES NOT extend to, but is not limited to other electronic appliances, commercial usage, units subjected misuse, neglect, accident, improper installation, transportation costs, unauthorized modification, violation of instructions, unauthorized repair, or alteration outside of the factory or any of our authorized facilities, units with altered, defaced, or removed serial numbers, satisfactory quality of fitness for a particular purpose, of accuracy, or sales or products outside of the United States.

OUT OF BOX FAILURES (hereby "OOBF") are limited to products that are inoperative or originally defective upon receipt. Under no circumstances will a consumer be permitted to return defective units directly to Criterion. Exchanges must be directly with the dealer. Proof of purchase with the printed date of purchase is mandatory. No oral or written information or advice given by Criterion, or its authorized representative shall create or overwrite this warranty. Should the product prove defective after the warranty, consumer accepts the product "as is", and assumes the entire cost of all necessary servicing, repair, or correction.

PRODUCT	MODEL #	PARTS	LABOR	COMPRESSOR
French Door Refrigerator	CFRR261WD** CFRR255WD**	1 Year	1 Year	1 Year
Top Freezer Refrigerator	CTMR183WD#* CTMR208WD#*			
Upright Freezer	CUF154WD*W CUF179WD*W CUF208WD*W			

If you have questions, please refer to the "Troubleshooting" section of this book. For further service and assistance, please contact Customer Service (toll-free) at **1-833-946-4227** or email **deamsvc@e-daewoo.com**